

HIGHLIGHTS OF PRESCRIBING INFORMATION

These highlights do not include all the information needed to use BRIXADI safely and effectively. See full prescribing information for BRIXADI.

BRIXADI™ (buprenorphine) extended-release injection for subcutaneous use CIII
Initial U.S. Approval: 2002

WARNING: RISK OF SERIOUS HARM OR DEATH WITH INTRAVENOUS ADMINISTRATION; BRIXADI RISK EVALUATION AND MITIGATION STRATEGY

See full prescribing information for complete boxed warning.

- **Serious harm or death could result if administered intravenously. (5.1)**
- **BRIXADI is only available through a restricted program called the BRIXADI REMS. Healthcare settings and pharmacies that order and dispense BRIXADI must be certified in this program and comply with the REMS requirements. (5.2)**

INDICATIONS AND USAGE

BRIXADI contains buprenorphine, a partial opioid agonist. BRIXADI is indicated for the treatment of moderate to severe opioid use disorder in patients who have initiated treatment with a single dose of a transmucosal buprenorphine product or who are already being treated with buprenorphine. (1)
BRIXADI should be used as part of a complete treatment plan that includes counseling and psychosocial support. (1)

DOSAGE AND ADMINISTRATION

- Prescription of this product is limited under the Drug Addiction Treatment Act. (2.1)
- Only healthcare providers should prepare and administer BRIXADI. (2.2)
- BRIXADI (weekly) and BRIXADI (monthly) are different formulations. Doses of BRIXADI (weekly) cannot be combined to yield an equivalent BRIXADI (monthly) dose. (2.2)
- BRIXADI should be injected slowly, into the subcutaneous tissue of the buttock, thigh, abdomen, or upper arm (2.2)
- Strongly consider prescribing naloxone at the time BRIXADI is initiated or renewed because patients being treated for opioid use disorder have the potential for relapse, putting them at risk for opioid overdose. (2.3)
- Injection sites for BRIXADI (weekly) should be alternated/rotated for each injection. (2.7)

See Full Prescribing Information for administration instructions. (2.7)

DOSAGE FORMS AND STRENGTHS

BRIXADI is a weekly and monthly injection provided in a pre-filled single-dose syringe with a 23 gauge ½ inch needle. (3)

- BRIXADI (weekly) is available in 8 mg/0.16 mL, 16 mg/0.32 mL, 24 mg/0.48 mL, and 32 mg/0.64 mL;
- BRIXADI (monthly) is available in 64 mg/0.18 mL, 96 mg/0.27 mL, and 128 mg/0.36 mL.

CONTRAINDICATIONS

Hypersensitivity to buprenorphine or any other ingredients in BRIXADI. (4)

WARNINGS AND PRECAUTIONS

- **Addiction, Abuse, and Misuse:** Buprenorphine can be abused in a manner similar to other opioids. Monitor patients for conditions indicative of diversion or progression of opioid dependence and addictive behaviors. (5.3)
- **Respiratory Depression:** Life-threatening respiratory depression and death have occurred in association with buprenorphine. Warn patients of the potential danger of self-administration of benzodiazepines or other CNS depressants while under treatment with BRIXADI. (5.4, 5.5)
- **Neonatal Opioid Withdrawal Syndrome:** Neonatal opioid withdrawal syndrome (NOWS) is an expected and treatable outcome of prolonged use of opioids during pregnancy. (5.6)
- **Adrenal Insufficiency:** If diagnosed, treat with physiologic replacement of corticosteroids, and wean patient off of the opioid. (5.7)
- **Risk of Opioid Withdrawal with Abrupt Discontinuation:** If treatment with BRIXADI is discontinued, monitor patients for withdrawal and treat appropriately. (5.8)
- **Risk of Hepatitis, Hepatic Events:** Monitor liver function tests prior to and during treatment. (5.9)
- **Latex Allergy:** The packaging of this product contains natural rubber latex which may cause allergic reactions. (5.10)
- **Risk of Withdrawal in Patients Dependent on Full Agonist Opioids:** Administer a test dose of transmucosal buprenorphine and monitor for precipitated withdrawal before injecting BRIXADI. (5.11)
- **Treatment of Emergent Acute Pain:** Treat pain with a non-opioid analgesic whenever possible. If opioid therapy is required, monitor patients closely because higher doses may be required for analgesic effect. (5.12)

ADVERSE REACTIONS

Adverse reactions commonly associated with BRIXADI administration (in ≥5% of patients) were injection site pain, headache, constipation, nausea, injection site erythema, injection site pruritus, insomnia, and urinary tract infection. (6.1)

To report SUSPECTED ADVERSE REACTIONS, contact Braeburn at 1-833-274-9234 or FDA at 1-800-FDA-1088 or www.fda.gov/medwatch.

DRUG INTERACTIONS

- **CYP3A4 Inhibitors and Inducers:** Monitor patients starting or ending CYP3A4 inhibitors or inducers for potential over or under dosing. (7)
- **Serotonergic Drugs:** If concomitant use is warranted, monitor for serotonin syndrome, particularly during treatment initiation, and during dose adjustment of the serotonergic drug. (7)

USE IN SPECIFIC POPULATIONS

- **Lactation:** Buprenorphine passes into the mother's milk. (8.2)
- **Geriatric Patients:** Monitor for sedation or respiratory depression. (8.5)
- **Moderate to Severe Hepatic Impairment:** Not recommended. (5.14, 8.6)

See 17 for PATIENT COUNSELING INFORMATION and Medication Guide.

Revised: xx/2022

FULL PRESCRIBING INFORMATION: CONTENTS*

WARNING: RISK OF SERIOUS HARM OR DEATH WITH INTRAVENOUS ADMINISTRATION; BRIXADI RISK EVALUATION AND MITIGATION STRATEGY

1 INDICATIONS AND USAGE

2 DOSAGE AND ADMINISTRATION

- 2.1 Drug Addiction Treatment Act
- 2.2 Important Dosage and Administration Instructions
- 2.3 Patient Access to Naloxone for the Emergency Treatment of Opioid Overdose
- 2.4 Recommended Dosing
- 2.5 Patient Selection
- 2.6 Clinical Supervision
- 2.7 Instructions for Use
- 2.8 Limits on Distribution
- 2.9 Removal of BRIXADI

3 DOSAGE FORMS AND STRENGTHS

4 CONTRAINDICATIONS

5 WARNINGS AND PRECAUTIONS

- 5.1 Risk of Serious Harm or Death with Intravenous Administration
- 5.2 BRIXADI Risk Evaluation and Mitigation Strategy (REMS)
- 5.3 Addiction, Abuse, and Misuse
- 5.4 Risk of Life-Threatening Respiratory and Central Nervous System (CNS) Depression
- 5.5 Managing Risks From Concomitant Use of Benzodiazepines or Other CNS Depressants with Buprenorphine
- 5.6 Neonatal Opioid Withdrawal Syndrome
- 5.7 Adrenal Insufficiency
- 5.8 Risk of Opioid Withdrawal with Abrupt Discontinuation of BRIXADI Treatment
- 5.9 Risk of Hepatitis, Hepatic Events
- 5.10 Hypersensitivity Reactions
- 5.11 Precipitation of Opioid Withdrawal Signs and Symptoms
- 5.12 Risks Associated with Treatment of Emergent Acute Pain

- 5.13 Use in Opioid Naïve Patients
- 5.14 Use in Patients with Impaired Hepatic Function
- 5.15 QTc Prolongation
- 5.16 Impairment of Ability to Drive and Operate Machinery
- 5.17 Orthostatic Hypotension
- 5.18 Elevation of Cerebrospinal Fluid Pressure
- 5.19 Elevation of Intracholedochal Pressure
- 5.20 Effects in Acute Abdominal Conditions
- 5.21 Unintentional Pediatric Exposure

6 ADVERSE REACTIONS

- 6.1 Clinical Trials Experience
- 6.2 Postmarketing Experience

7 DRUG INTERACTIONS

8 USE IN SPECIFIC POPULATIONS

- 8.1 Pregnancy
- 8.2 Lactation
- 8.3 Females and Males of Reproductive Potential
- 8.4 Pediatric Use
- 8.5 Geriatric Use
- 8.6 Hepatic Impairment
- 8.7 Renal Impairment

9 DRUG ABUSE AND DEPENDENCE

- 9.1 Controlled Substance
- 9.2 Abuse
- 9.3 Dependence

10 OVERDOSAGE

11 DESCRIPTION

12 CLINICAL PHARMACOLOGY

- 12.1 Mechanism of Action
- 12.2 Pharmacodynamics
- 12.3 Pharmacokinetics

13 NONCLINICAL TOXICOLOGY

- 13.1 Carcinogenesis, Mutagenesis, Impairment of Fertility

14 CLINICAL STUDIES

- 14.1 Opioid Blockade Study, NCT02611752
- 14.2 Phase 3 Double-Blind Study, NCT02651584

16 HOW SUPPLIED/STORAGE AND HANDLING

17 PATIENT COUNSELING INFORMATION

* Sections or subsections omitted from the full prescribing information are not listed.

FULL PRESCRIBING INFORMATION

WARNING: RISK OF SERIOUS HARM OR DEATH WITH INTRAVENOUS ADMINISTRATION; BRIXADI RISK EVALUATION AND MITIGATION STRATEGY

- **Serious harm or death could result if administered intravenously. BRIXADI forms a liquid crystalline gel upon contact with body fluids and may cause occlusion, local tissue damage, and thrombo-embolic events, including life-threatening pulmonary emboli, if administered intravenously. (5.1)**
- **Because of the risk of serious harm or death that could result from intravenous self-administration, BRIXADI is only available through a restricted program called the BRIXADI REMS. Healthcare settings and pharmacies that order and dispense BRIXADI must be certified in this program and comply with the REMS requirements. (5.2)**

1 INDICATIONS AND USAGE

BRIXADI is indicated for the treatment of moderate to severe opioid use disorder in patients who have initiated treatment with a single dose of a transmucosal buprenorphine product or who are already being treated with buprenorphine.

BRIXADI should be used as part of a complete treatment plan that includes counseling and psychosocial support.

2 DOSAGE AND ADMINISTRATION

2.1 Drug Addiction Treatment Act

Under the Drug Addiction Treatment Act (DATA) codified at 21 U.S.C. 823(g), prescription use of this product in the treatment of opioid dependence is limited to healthcare providers who meet certain qualifying requirements, and who have notified the Secretary of Health and Human Services (HHS) of their intent to prescribe this product for the treatment of opioid dependence and have been assigned a unique identification number that must be included on every prescription.

2.2 Important Dosage and Administration Instructions

FOR SUBCUTANEOUS INJECTION ONLY. DO NOT ADMINISTER BRIXADI INTRAVENOUSLY, INTRAMUSCULARLY, OR INTRADERMALLY [*see Warnings and Precautions (5.1), Instructions for Use (2.7)*].

- BRIXADI exists in two formulations.
- Doses of BRIXADI (weekly) cannot be combined to yield a monthly dose.
- Only healthcare providers should prepare and administer BRIXADI.
- Administer BRIXADI as a single injection. Do not divide.

- BRIXADI should be injected slowly, into the subcutaneous tissue of the buttock, thigh, abdomen, or upper arm.
 - In patients who are not currently receiving buprenorphine treatment, for BRIXADI (weekly), the upper arm site should only be used after steady-state has been achieved (4 consecutive doses) [see *Instructions for Use (2.7)*]. Injection in the arm site was associated with approximately 10% lower plasma levels than other sites.
- Injection sites should be alternated/rotated between injections for BRIXADI (weekly) [see *Instructions for Use (2.7)*].
- For all patients, the dose of BRIXADI must be individualized based on patient tolerability and/or efficacy.
- BRIXADI (weekly) should be administered in 7-day intervals.
- BRIXADI (monthly) should be administered in 28-day intervals.
- For patients not currently receiving buprenorphine treatment, begin with a test dose of 4 mg transmucosal buprenorphine to establish that buprenorphine is tolerated without precipitated withdrawal, and then transition to BRIXADI (weekly). Initiating treatment with BRIXADI as the first buprenorphine product has not been studied. Initiating treatment with BRIXADI (monthly) in new entrants to treatment has not been studied [see *Dosage and Administration (2.3)*].
- Patients who are currently being treated with other buprenorphine-containing products can start treatment with either BRIXADI (weekly) or BRIXADI (monthly) [see *Dosage and Administration (2.3)*].
- Administer each injection using only the syringe and safety needle included with the product [see *Instructions for Use (2.7)*]. Caution: The BRIXADI needle cap is synthetically derived from natural rubber latex which may cause allergic reactions in latex-sensitive individuals [see *Warnings and Precautions (5.10)*].

To avoid missed doses, the weekly dose may be administered up to 2 days before or after the weekly time point, and the monthly dose may be administered up to 1 week before or after the monthly time point.

If a dose is missed, the next dose should be administered as soon as practically possible.

2.3 Patient Access to Naloxone for the Emergency Treatment of Opioid Overdose

Discuss the availability of naloxone for the emergency treatment of opioid overdose with the patient and caregiver. Because patients being treated for opioid use disorder have the potential for relapse, putting them at risk for opioid overdose, strongly consider prescribing naloxone for the emergency treatment of opioid overdose, both when initiating and renewing treatment with BRIXADI. Also consider prescribing naloxone if the patient has household members (including children) or other close contacts at risk for accidental ingestion or opioid overdose [see *Warnings and Precautions (5.4)*].

Advise patients and caregivers that naloxone may also be administered for a known or suspected overdose with buprenorphine itself. Higher than normal doses and repeated administration of

naloxone may be necessary due to the long duration of action of buprenorphine and its affinity for the mu receptor [see *Overdosage (10)*].

Inform patients and caregivers of their options for obtaining naloxone as permitted by individual state naloxone dispensing and prescribing requirements or guidelines (e.g., by prescription, directly from a pharmacist, or as part of a community-based program) [see *Patient Counseling Information (17)*].

2.4 Recommended Dosing

Patients Not Currently Receiving Buprenorphine Treatment

The recommended weekly dose in patients not currently receiving buprenorphine treatment is 24 mg of BRIXADI (weekly) titrated up over the first week of treatment as follows:

1. To avoid precipitating an opioid withdrawal syndrome, administer a test dose of transmucosal buprenorphine 4 mg when objective signs of mild to moderate withdrawal appear.
2. If the dose of transmucosal buprenorphine is tolerated without precipitated withdrawal, administer the first dose of BRIXADI (weekly), 16 mg.
3. Administer an additional dose of 8 mg BRIXADI (weekly) within 3 days of the first dose to achieve the recommended 24 mg BRIXADI (weekly) dose.

If needed, during this first week of treatment, administer an additional 8 mg dose of BRIXADI (weekly), waiting at least 24 hours after the previous injection, for a total weekly dose of 32 mg BRIXADI (weekly).

Administer subsequent BRIXADI (weekly) injections based on the total weekly dose that was established during Week One. Dosage adjustments can be made at weekly appointments with the maximum BRIXADI (weekly) dose being 32 mg.

A patient who misses a dose of BRIXADI (weekly) should receive the next dose as soon as possible. BRIXADI (weekly) should be administered in 7-day intervals.

Patients Switching from Transmucosal Buprenorphine-containing Products to BRIXADI

Patients currently being treated with a transmucosal buprenorphine-containing product may be switched directly to either BRIXADI (weekly) or BRIXADI (monthly).

Table 1 identifies the corresponding dose of BRIXADI when switching a patient from transmucosal buprenorphine to BRIXADI (weekly) or BRIXADI (monthly), expressing the transmucosal dose equivalents in terms of Subutex or Suboxone doses.

Table 1: Daily doses of sublingual buprenorphine (Subutex, Suboxone, or generic product equivalents) and suggested corresponding BRIXADI (weekly) or BRIXADI (monthly) doses

| Daily dose of sublingual buprenorphine | BRIXADI (weekly) | BRIXADI (monthly) |
|--|------------------|-------------------|
| ≤ 6 mg | 8 mg | -- |

| | | |
|----------|-------|--------|
| 8-10 mg | 16 mg | 64 mg |
| 12-16 mg | 24 mg | 96 mg |
| 18-24 mg | 32 mg | 128 mg |

Note: One SUBOXONE® (buprenorphine and naloxone) 8 mg/2 mg sublingual tablet provides equivalent buprenorphine exposure to one SUBUTEX® (buprenorphine HCl) 8 mg sublingual tablet or one Zubsolv® (buprenorphine and naloxone) 5.7 mg/1.4 mg sublingual tablet.

Patients Transitioning Between BRIXADI (weekly) and BRIXADI (monthly)

Patients may be transitioned from weekly to monthly or from monthly to weekly dosing of BRIXADI based on clinical judgment (see Table 2).

Table 2: Recommended dose when transitioning between BRIXADI (weekly) and BRIXADI (monthly)

| BRIXADI (weekly) | BRIXADI (monthly) |
|-------------------------|--------------------------|
| 16 mg | 64 mg |
| 24 mg | 96 mg |
| 32 mg | 128 mg |

A patient who misses a dose of BRIXADI should receive the next dose as soon as possible. BRIXADI (weekly) should be administered in 7-day intervals. BRIXADI (monthly) should be administered in 28-day intervals.

Dose Adjustments of BRIXADI

An additional BRIXADI (weekly) 8 mg injection may be administered, based on clinical judgment during a dosing interval, up to a maximum dose of 32 mg per week of BRIXADI (weekly) or 128 mg per month of BRIXADI (monthly).

2.5 Patient Selection

Patients appropriate for BRIXADI (weekly) are:

1. adults who have tolerated a single 4 mg dose of a transmucosal buprenorphine-containing product. The test dose of transmucosal buprenorphine-containing product should be administered based on instructions in the appropriate product label.
2. adults who are currently being treated with a transmucosal buprenorphine-containing product.

Patients appropriate for BRIXADI (monthly) are adults who are currently being treated with a transmucosal buprenorphine-containing product. BRIXADI (monthly) is not intended for patients who are not currently receiving buprenorphine treatment.

2.6 Clinical Supervision

Periodic assessment is necessary to determine effectiveness of the treatment plan and overall patient progress. When evaluating the patient, examine the injection site for signs of infection or evidence of tampering or attempts to remove the depot.

Due to the chronic nature of opioid use disorder, the need for continuing medication-assisted treatment should be re-evaluated periodically. There is no maximum recommended duration of maintenance treatment. For some patients, treatment may continue indefinitely. If considering stopping treatment, the clinical status of the patient should be considered.

If BRIXADI is discontinued, its extended-release characteristics should be considered, and the patient should be monitored for several months for signs and symptoms of withdrawal and treated appropriately. After steady-state has been achieved, which is 4 weeks for BRIXADI (weekly) and 4 months for BRIXADI (monthly), patients discontinuing BRIXADI may have detectable plasma levels of buprenorphine for approximately 1 month for BRIXADI (weekly) and for approximately 4 months for BRIXADI (monthly). The correlation between plasma concentrations of buprenorphine and those detectable in urine is not known.

2.7 Instructions for Use

Prior to injecting BRIXADI, carefully read the instructions as well as the full prescribing information.

IMPORTANT INFORMATION:

- For subcutaneous injection only [*see Warnings and Precautions (5.1)*].
- To be prepared and administered by a healthcare provider only.
- Read the instructions carefully before handling the product.
- As a universal precaution, always wear gloves and inject BRIXADI under aseptic conditions.
- BRIXADI should be injected slowly, into the subcutaneous tissue of the buttock, thigh, abdomen, or upper arm.
- In patients who are not currently receiving buprenorphine treatment, for BRIXADI (weekly), the upper arm site should only be used after steady-state has been achieved (4 consecutive doses). Injection in the arm site was associated with approximately 10% lower plasma levels than other sites.
- Discard BRIXADI if the liquid contains visible particles or is cloudy. Discard BRIXADI after the expiration date shown on the carton or on the safety syringe label.

SAFETY SYRINGE PARTS (see Figures 1, 2, and 3 below)

Figure 1.

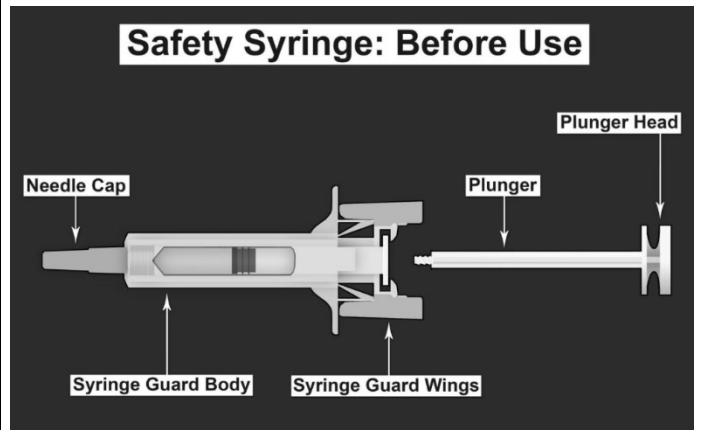

Figure 2.

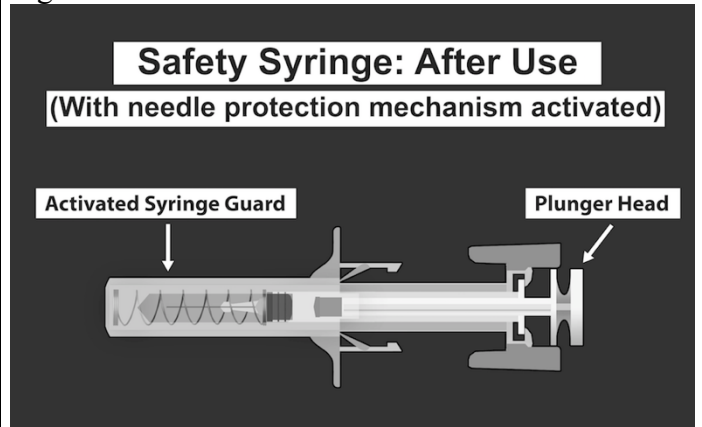
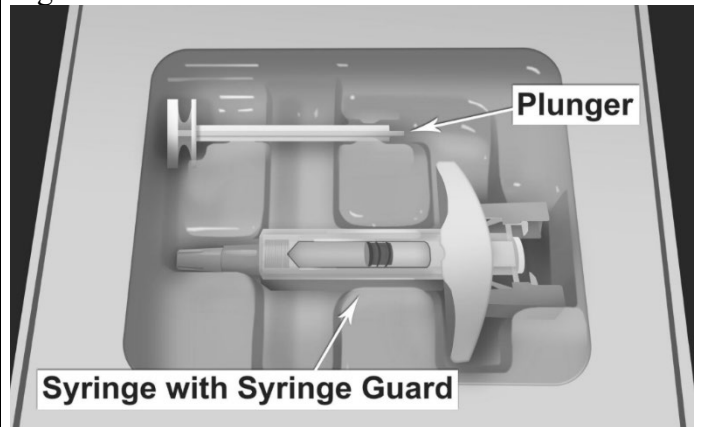

Figure 3.



MATERIALS NEEDED FOR INJECTION

Illustrated in Figure 4.

- Alcohol wipe
- Cotton ball
- Sharps disposal container

Figure 4.



SELECTING AN INJECTION SITE

The areas for subcutaneous injection are highlighted in Figure 5. **BRIXADI should not be administered to the same site of injection for at least 8 weeks for BRIXADI (weekly). No injection site rotation is required for BRIXADI (monthly).**

BRIXADI should be injected slowly, into the subcutaneous tissue of the buttock, thigh, abdomen, or upper arm.

In patients who are not currently receiving buprenorphine treatment, for BRIXADI (weekly), the upper arm site should only be used after steady-state has been achieved (after 4 consecutive doses) [see *Dosage and Administration (2.2)*].

Figure 5.

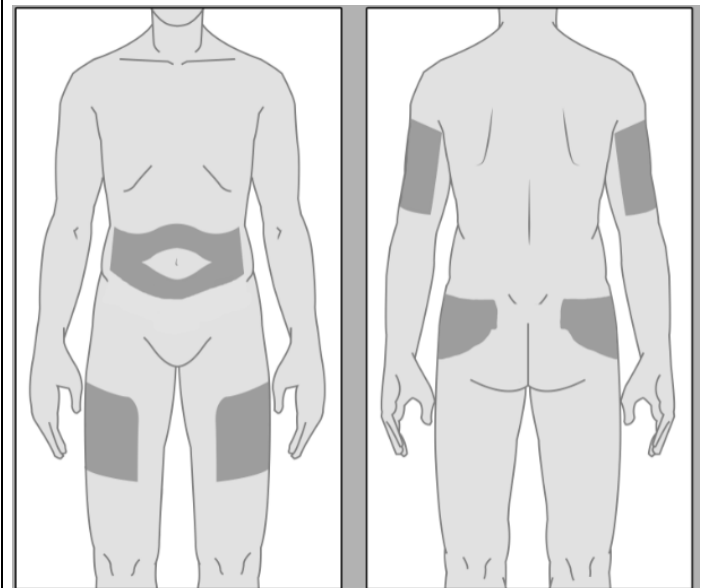

PREPARE THE SAFETY SYRINGE

Step 1:

Wash hands thoroughly with soap and water prior to handling the safety syringe.

Step 2:

Remove the safety syringe components from the carton. Assemble the safety syringe. While holding the syringe guard body, insert the plunger into the body of the syringe and rotate clockwise until it is attached to the stopper inside the syringe as illustrated in Figure 6.

Figure 6.

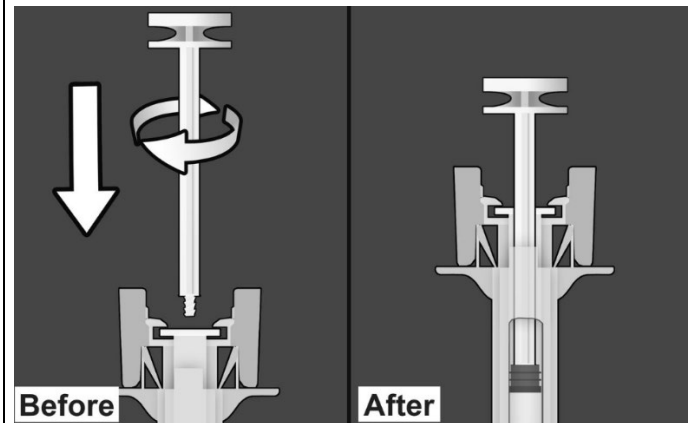

Step 3:

Inspect the safety syringe closely:

Do not use the safety syringe after the expiration date shown on the carton or on the safety syringe label.

- The liquid should be clear and yellowish to yellow in color.
- A small air bubble may be visible.

Do not use the safety syringe if the liquid contains visible particles or is cloudy.

PREPARATION OF SITE

Step 4:

- Put on gloves.
- Clean the injection site with an alcohol wipe using a circular motion.

Do not touch the cleaned area again before injecting.

ADMINISTERING INJECTION

Step 5:

- Grasp the safety syringe by the syringe, as shown (see Figure 7).
- Carefully pull the needle cap straight off.
- Immediately dispose of the needle cap (Never try to recap the needle).

It is normal to see a small drop of liquid at the tip of the needle.

Figure 7.



Step 6:

Pinch the skin at the injection site between your thumb and index finger as shown in Figure 8.

Figure 8.

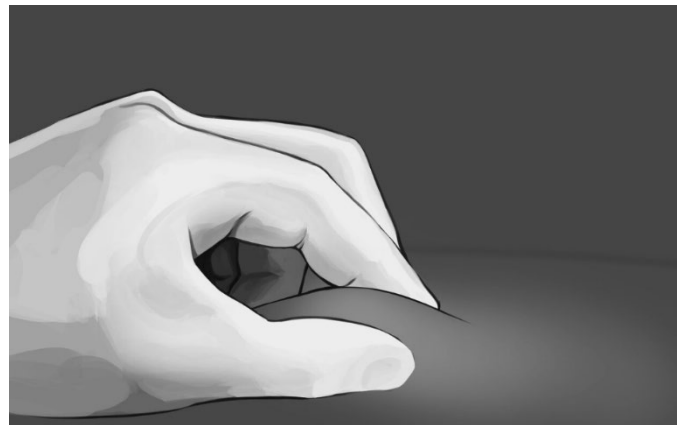

Step 7:

Hold the syringe, as shown, and insert the needle at an angle of approximately 90° (see Figure 9). The needle is designed to inject into the subcutaneous space. It is important to fully insert the needle.

Figure 9.

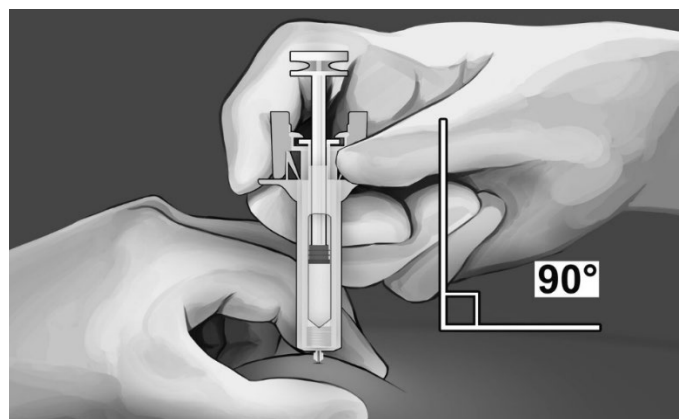

Step 8:

- After the needle is completely inserted into the subcutaneous tissue, release the skin that you are grasping. Slowly press down the plunger head until it latches in the safety device ‘wings’ (see Figure 10). This will ensure that all of the medication has been injected.
- **Keep the plunger pressed fully down while you hold the safety syringe in place for an additional 2 seconds.**

Figure 10.

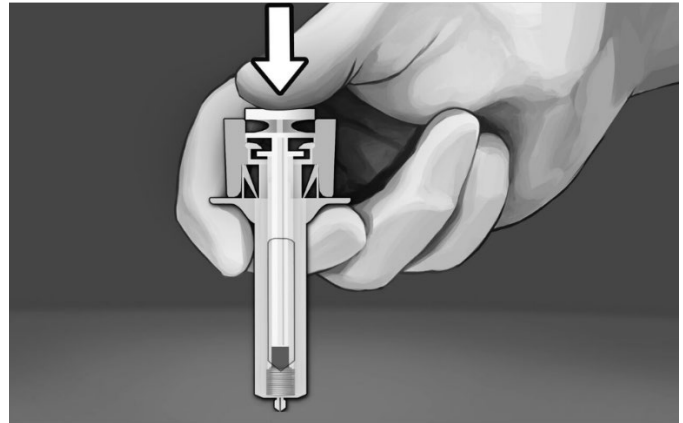

Step 9:

- Gently pull the needle out of the skin.
- Keep the plunger fully depressed while you carefully lift the needle straight out from the injection site (see Figure 11).

Figure 11.

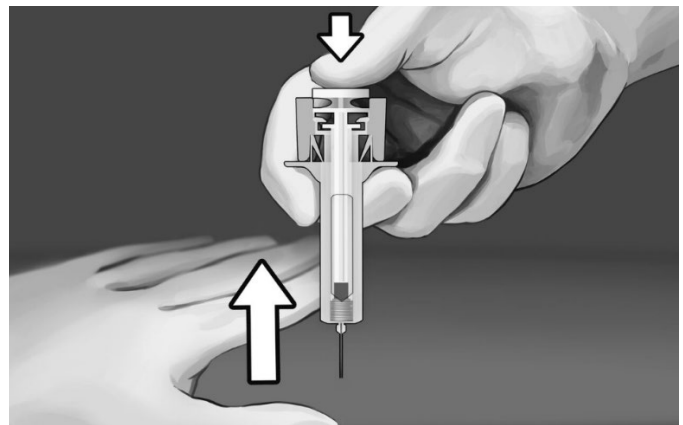

Step 10:

- As soon as you have completely removed the needle from the skin, slowly take your thumb off the plunger.
- Allow the syringe guard to automatically cover the exposed needle (see Figure 12).
- There may be a small amount of blood at the injection site. If needed, wipe with a cotton ball or gauze.

Figure 12.

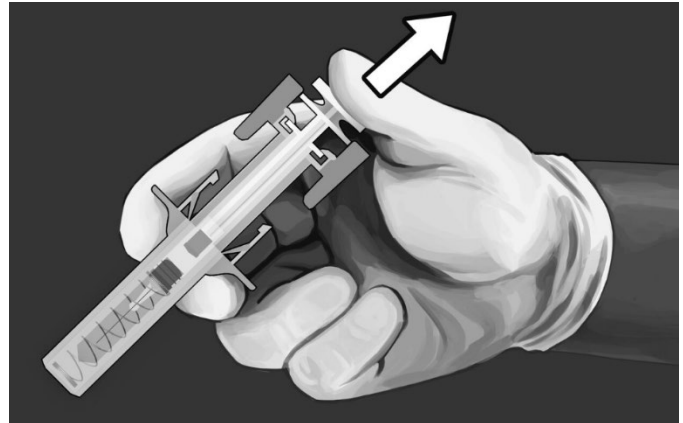

DISPOSAL OF USED SAFETY SYRINGE

Step 11:

Put the used safety syringe immediately into a sharps container (see Figure 13).

POST INJECTION CARE

- Examine the injection site.
- If there is blood, press a cotton ball or gauze pad on the injection site.
- Do not rub the injection site.
- Apply an adhesive bandage if needed.
- Patient should be instructed to notify you immediately if excessive swelling, redness, heat or drainage develops at the injection site.

Figure 13.



2.8 Limits on Distribution

BRIXADI is subject to a risk evaluation and mitigation strategy (REMS) program that includes, among other elements, a restricted distribution program. The purpose of the restricted distribution program is to ensure that BRIXADI is only administered by a healthcare provider [see *Warnings and Precautions (5.2)*].

2.9 Removal of BRIXADI

BRIXADI forms a biodegradable liquid crystalline gel upon injection that is not always palpable and may not be conducive to surgical removal. Therefore, removal is not recommended.

3 DOSAGE FORMS AND STRENGTHS

BRIXADI is a sterile, yellowish to yellow-clear liquid solution and is provided as two different formulations, one for weekly and one for monthly administration in pre-filled, single-dose, syringes, with 23 gauge ½ inch needles, available in the following dosage strengths.

Table 3: BRIXADI (weekly) Strengths

| BRIXADI (weekly) 50 mg/mL buprenorphine | |
|--|----------------------|
| Dosage Strength | Dosage Volume |
| 8 mg | 0.16 mL |
| 16 mg | 0.32 mL |
| 24 mg | 0.48 mL |
| 32 mg | 0.64 mL |

Table 4: BRIXADI (monthly) Strengths

| BRIXADI (monthly) 356 mg/mL buprenorphine | |
|--|----------------------|
| Dosage Strength | Dosage Volume |
| 64 mg | 0.18 mL |
| 96 mg | 0.27 mL |
| 128 mg | 0.36 mL |

4 CONTRAINDICATIONS

BRIXADI is contraindicated in patients with hypersensitivity (e.g., anaphylactic shock) to buprenorphine, or any other ingredients in the solution for injection [see *Warnings and Precautions (5.10)*].

5 WARNINGS AND PRECAUTIONS

5.1 Risk of Serious Harm or Death with Intravenous Administration

Intravenous injection presents significant risk of serious harm or death as BRIXADI forms a liquid crystalline gel upon contact with body fluids. Occlusion, local tissue damage, and thrombo-embolic events, including life-threatening pulmonary emboli, could result if administered intravenously [*see Warnings and Precautions (5.2), Drug Abuse and Dependence (9.2)*]. Do not administer intravenously, intramuscularly, or intradermally.

5.2 BRIXADI Risk Evaluation and Mitigation Strategy (REMS)

BRIXADI is available only through a restricted program called the BRIXADI REMS because of the risk of serious harm or death that could result from intravenous self-administration. The goal of the REMS is to mitigate serious harm or death that could result from intravenous self-administration by ensuring that healthcare settings and pharmacies are certified and only dispense BRIXADI directly to a healthcare provider for administration by a healthcare provider.

Notable requirements of the BRIXADI REMS include the following:

- Healthcare Settings and Pharmacies that order and dispense BRIXADI must be certified in the BRIXADI REMS.
- Certified Healthcare Settings and Pharmacies must establish processes and procedures to verify BRIXADI is provided directly to a healthcare provider for administration by a healthcare provider, and the drug is not dispensed to the patient.
- Certified Healthcare Settings and Pharmacies must not distribute, transfer, loan, or sell BRIXADI.

Further information is available at www.BRIXADIREMS.com or by calling 1-833-274-9234.

5.3 Addiction, Abuse, and Misuse

BRIXADI contains buprenorphine, a Schedule III controlled substance that can be abused in a manner similar to other opioids. Buprenorphine is sought by people with opioid use disorder and is subject to criminal diversion. Monitor all patients for progression of opioid use disorder and addictive behaviors [*see Drug Abuse and Dependence (9.2)*].

5.4 Risk of Life-Threatening Respiratory and Central Nervous System (CNS) Depression

Buprenorphine has been associated with life-threatening respiratory depression and death. Many, but not all, postmarketing reports regarding coma and death involved misuse by self-injection or were associated with the concomitant use of buprenorphine and benzodiazepines or other CNS depressant drugs including alcohol. Warn patients of the potential danger of self-administration of benzodiazepines or other CNS depressants while under treatment with BRIXADI [*see Drug Interactions (7), Warnings and Precautions (5.5), Patient Counseling Information (17)*].

Use BRIXADI with caution in patients with compromised respiratory function (e.g., chronic obstructive pulmonary disease, cor pulmonale, decreased respiratory reserve, hypoxia, hypercapnia, or pre-existing respiratory depression).

Due to its extended-release characteristics, if BRIXADI is discontinued as a result of compromised respiratory function, monitor patients for ongoing buprenorphine effects for approximately 1 month for BRIXADI (weekly) and for approximately 4 months for BRIXADI (monthly).

Educate patients and caregivers on how to recognize respiratory depression and emphasize the importance of calling 911 or getting emergency medical help right away in the event of a known or suspected overdose [see *Patient Counseling Information (17)*].

Opioids can cause sleep-related breathing disorders including central sleep apnea (CSA) and sleep related hypoxemia. Opioid use increases the risk of CSA in a dose-dependent fashion. In patients who present with CSA, monitor patient during treatment and consider dose reduction using best practices for opioid taper. [see *Clinical Supervision (2.6)*].

Patient Access to Naloxone for the Emergency Treatment of Opioid Overdose

Discuss the availability of naloxone for the emergency treatment of opioid overdose with the patient and caregiver.

Because patients being treated for opioid use disorder have the potential for relapse, putting them at risk for opioid overdose, strongly consider prescribing naloxone for the emergency treatment of opioid overdose, both when initiating and renewing treatment with BRIXADI. Also consider prescribing naloxone if the patient has household members (including children) or other close contacts at risk for accidental ingestion or opioid overdose [see *Dosage and Administration (2.3)*].

Advise patients and caregivers that naloxone may also be administered for a known or suspected overdose with buprenorphine itself. Higher than normal doses and repeated administration of naloxone may be necessary due to the long duration of action of buprenorphine and its affinity for the mu receptor [see *Overdosage (10)*].

Inform patients and caregivers of their options for obtaining naloxone as permitted by individual state naloxone dispensing and prescribing requirements or guidelines (e.g., by prescription, directly from a pharmacist, or as part of a community-based program).

Educate patients and caregivers on how to recognize respiratory depression and, if naloxone is prescribed, how to treat with naloxone. Emphasize the importance of calling 911 or getting emergency medical help, even if naloxone is administered [see *Patient Counseling Information (17)*].

5.5 Managing Risks From Concomitant Use of Benzodiazepines or Other CNS Depressants with Buprenorphine

Concomitant use of buprenorphine and benzodiazepines or other CNS depressants increases the risk of adverse reactions including respiratory depression, overdose, and death. Medication-assisted treatment of opioid use disorder, however, should not be categorically denied to patients taking these drugs. Prohibiting or creating barriers to treatment can pose an even greater risk of morbidity and mortality due to the opioid use disorder alone.

As a routine part of orientation to buprenorphine treatment, educate patients about the risks of concomitant use of benzodiazepines sedatives, opioid analgesics, and alcohol.

Develop strategies to manage use of prescribed or illicit benzodiazepines or other CNS depressants at initiation of buprenorphine treatment, or if it emerges as a concern during treatment. Adjustments to induction procedures and additional monitoring may be required. There is no evidence to support dose limitations or arbitrary caps of buprenorphine as a strategy to address benzodiazepine use in buprenorphine-treated patients. However, if a patient is sedated at the time of buprenorphine dosing, delay or omit the buprenorphine dose if appropriate.

Cessation of benzodiazepines or other CNS depressants is preferred in most cases of concomitant use with buprenorphine. In some cases, monitoring in a higher level of care for taper may be appropriate. In others, gradually tapering a patient off of a prescribed benzodiazepine or other CNS depressant or decreasing to the lowest effective dose may be appropriate.

For patients in buprenorphine treatment, benzodiazepines are not the treatment of choice for anxiety or insomnia. Before co-prescribing benzodiazepines, ensure that patients are appropriately diagnosed and consider alternative medications and non-pharmacologic treatments to address anxiety or insomnia. Ensure that other healthcare providers prescribing benzodiazepines or other CNS depressants are aware of the patients' buprenorphine treatment and coordinate care to minimize the risks associated with concomitant use.

If concomitant use is warranted, strongly consider prescribing naloxone for the emergency treatment of opioid overdose, as is recommended for all patients in buprenorphine treatment for opioid use disorder [*see Warnings and Precautions (5.4)*].

In addition, take measures to confirm that patients are taking their medications as prescribed and are not diverting or supplementing with illicit drugs. Toxicology screening should test for prescribed and illicit benzodiazepines [*see Drug Interactions (7)*].

5.6 Neonatal Opioid Withdrawal Syndrome

Neonatal opioid withdrawal syndrome (NOWS) is an expected and treatable outcome of prolonged use of opioids during pregnancy, whether that use is medically-authorized or illicit. Unlike opioid withdrawal syndrome in adults, NOWS may be life-threatening if not recognized and treated in the neonate. Healthcare providers should observe newborns for signs of NOWS and manage accordingly [*see Use in Specific Populations (8.1)*].

Advise pregnant women receiving opioid addiction treatment with BRIXADI of the risk of neonatal opioid withdrawal syndrome and ensure that appropriate treatment will be available [*see Use in Specific Populations (8.1)*]. This risk must be balanced against the risk of untreated opioid addiction which often results in continued or relapsing illicit opioid use and is associated with poor pregnancy outcomes. Therefore, prescribers should discuss the importance and benefits of management of opioid addiction throughout pregnancy.

5.7 Adrenal Insufficiency

Cases of adrenal insufficiency have been reported with opioid use, more often following greater than one month of use. Presentation of adrenal insufficiency may include non-specific symptoms and signs including nausea, vomiting, anorexia, fatigue, weakness, dizziness, and low blood pressure. If adrenal insufficiency is suspected, confirm the diagnosis with diagnostic testing as soon as possible. If adrenal insufficiency is diagnosed, treat with physiologic replacement doses

of corticosteroids. Wean the patient off of the opioid to allow adrenal function to recover and continue corticosteroid treatment until adrenal function recovers. Other opioids may be tried as some cases reported use of a different opioid without recurrence of adrenal insufficiency. The information available does not identify any particular opioids as being more likely to be associated with adrenal insufficiency.

5.8 Risk of Opioid Withdrawal with Abrupt Discontinuation of BRIXADI Treatment

Buprenorphine is a partial agonist at the mu-opioid receptor and chronic administration produces physical dependence of the opioid type, characterized by withdrawal signs and symptoms upon abrupt discontinuation or rapid taper. The withdrawal syndrome is milder than that seen with full agonists and may be delayed in onset [*see Drug Abuse and Dependence (9.2, 9.3)*].

Patients who elect to discontinue BRIXADI treatment should be monitored for withdrawal signs and symptoms [*See Clinical Pharmacology (12.3)*].

Consider transmucosal buprenorphine if needed to treat withdrawal after discontinuing BRIXADI.

5.9 Risk of Hepatitis, Hepatic Events

Cases of cytolytic hepatitis and hepatitis with jaundice have been observed in individuals receiving buprenorphine for the treatment of opioid use disorder, both in clinical trials and through postmarketing adverse event reports.

The spectrum of abnormalities ranges from transient asymptomatic elevations in hepatic transaminases to case reports of death, hepatic failure, hepatic necrosis, hepatorenal syndrome, and hepatic encephalopathy. In many cases, the presence of pre-existing liver enzyme abnormalities, infection with hepatitis B or hepatitis C virus, concomitant usage of other potentially hepatotoxic drugs, and ongoing injection drug abuse may have played a causative or contributory role. In other cases, insufficient data were available to determine the etiology of the abnormality. Withdrawal of buprenorphine has resulted in amelioration of acute hepatitis in some cases; however, in other cases no dose reduction was necessary. The possibility exists that buprenorphine had a causative or contributory role in the development of the hepatic abnormality in some cases.

Liver function tests are recommended prior to initiation of treatment to establish a baseline. Periodic monitoring of liver function during treatment is also recommended. A biological and etiological evaluation is recommended when a hepatic event is suspected. Monitor patients with declining hepatic function for side effects resulting from increased exposure to buprenorphine.

5.10 Hypersensitivity Reactions

Cases of hypersensitivity to buprenorphine containing products have been reported both in clinical trials and in the postmarketing experience. Cases of bronchospasm, angioneurotic edema, and anaphylactic shock have been reported. The most common signs and symptoms include

rashes, hives, and pruritus. A history of hypersensitivity to buprenorphine or other components is a contraindication to the use of BRIXADI [see *Contraindications (4)*].

Latex Allergies: The BRIXADI needle cap is synthetically derived from natural rubber latex which may cause allergic reactions in latex-sensitive individuals.

5.11 Precipitation of Opioid Withdrawal Signs and Symptoms

Because of the partial agonist properties of buprenorphine, BRIXADI injection may precipitate opioid withdrawal signs and symptoms in individuals physically dependent on full opioid agonists such as heroin, morphine, or methadone before the effects of the full opioid agonist have subsided.

In patients who are new entrants to treatment, administer a test dose of transmucosal buprenorphine and monitor for precipitated withdrawal and treat appropriately [see *Dosage and Administration (2.3)*].

5.12 Risks Associated with Treatment of Emergent Acute Pain

While on BRIXADI, situations may arise where patients need acute pain management, or may require anesthesia. Treat patients receiving BRIXADI with non-opioid analgesic whenever possible. Patients requiring opioid therapy for analgesia may be treated with a high-affinity full opioid analgesic under the supervision of a healthcare provider, with particular attention to respiratory function. Higher doses may be required for analgesic effect. Therefore, a higher potential for toxicity exists with opioid administration. If opioid therapy is required as part of anesthesia, patients should be continuously monitored in an anesthesia care setting by persons not involved in the conduct of the surgical or diagnostic procedure. The opioid therapy should be provided by individuals specifically trained in the use of anesthetic drugs and the management of the respiratory effects of potent opioids, specifically the establishment and maintenance of a patent airway and assisted ventilation.

Advise patients of the importance of instructing their family members, in the event of emergency, to inform the treating healthcare provider or emergency room staff that the patient is physically dependent on an opioid and that the patient is being treated with BRIXADI [see *Patient Counseling Information (17)*].

The above guidance should also be considered for any patient who has been treated with BRIXADI within the last 6 months.

5.13 Use in Opioid Naïve Patients

There have been reported deaths of opioid naïve individuals who received a 2 mg dose of buprenorphine as a sublingual tablet. BRIXADI is not appropriate for use in opioid naïve patients.

5.14 Use in Patients With Impaired Hepatic Function

In a pharmacokinetic study with transmucosal buprenorphine, buprenorphine plasma levels were found to be higher and the half-life was found to be longer in subjects with moderate and severe hepatic impairment, but not in subjects with mild hepatic impairment. The effect of hepatic impairment on the pharmacokinetics of BRIXADI, has not been studied.

Because of the long-acting nature of the product, adjustments to dosages of BRIXADI are not rapidly reflected in plasma buprenorphine levels. Because buprenorphine levels cannot be rapidly decreased, patients with pre-existing moderate to severe hepatic impairment are not candidates for treatment with BRIXADI.

Patients who develop moderate to severe hepatic impairment while being treated with BRIXADI should be monitored for several months for signs and symptoms of toxicity or overdose caused by increased levels of buprenorphine and patients may require a dose adjustment [*see Use in Specific Populations (8.6)*].

5.15 QTc Prolongation

Thorough QT studies with buprenorphine products have demonstrated QT prolongation ≤ 15 msec. This QTc prolongation effect does not appear to be mediated by hERG channels. Based on these two findings, buprenorphine is unlikely to be pro-arrhythmic when used alone in patients without risk factors. The risk of combining buprenorphine with other QT- prolonging agents is not known.

Consider these observations in clinical decisions with prescribing BRIXADI to patients with risk factors such as hypokalemia, bradycardia, recent conversion from atrial fibrillation, congestive heart failure, digitalis therapy, baseline QT prolongation, subclinical long-QT syndrome, or severe hypomagnesemia. [*see Clinical Pharmacology (12.2)*].

5.16 Impairment of Ability to Drive and Operate Machinery

BRIXADI may impair the mental or physical abilities required for the performance of potentially dangerous tasks such as driving a car or operating machinery, especially for the first few days following treatment and dose adjustment. Buprenorphine plasma levels accumulate during the BRIXADI (weekly) or BRIXADI (monthly) injections, which achieves steady-state at the fourth weekly or monthly injection. Caution patients about driving or operating hazardous machinery until they are reasonably certain that BRIXADI does not adversely affect their ability to engage in such activities. [*see Clinical Pharmacology (12.3)*].

5.17 Orthostatic Hypotension

Buprenorphine may produce orthostatic hypotension in ambulatory patients.

5.18 Elevation of Cerebrospinal Fluid Pressure

Buprenorphine may elevate cerebrospinal fluid pressure and should be used with caution in patients with head injury, intracranial lesions, and other circumstances where cerebrospinal

pressure may be increased. Buprenorphine can produce miosis and changes in the level of consciousness that may interfere with patient evaluation.

5.19 Elevation of Intracholedochal Pressure

Buprenorphine has been shown to increase intracholedochal pressure, as do other opioids, and thus should be administered with caution to patients with dysfunction of the biliary tract.

5.20 Effects in Acute Abdominal Conditions

Buprenorphine may obscure the diagnosis or clinical course of patients with acute abdominal conditions.

5.21 Unintentional Pediatric Exposure

Buprenorphine can cause severe, possibly fatal, respiratory depression in children who are accidentally exposed to it.

6 ADVERSE REACTIONS

The following adverse reactions are discussed in more detail in other sections of the labeling:

- Addiction, Abuse, and Misuse [*see Warnings and Precautions (5.3)*]
- Respiratory and CNS Depression [*see Warnings and Precautions (5.4)*]
- Neonatal Opioid Withdrawal Syndrome [*see Warnings and Precautions (5.6)*]
- Adrenal Insufficiency [*see Warnings and Precautions (5.7)*]
- Opioid Withdrawal [*see Warnings and Precautions (5.8, 5.11)*]
- Hepatitis, Hepatic Events [*see Warnings and Precautions (5.9)*]
- Hypersensitivity Reactions [*see Warnings and Precautions (5.10)*]
- Orthostatic Hypotension [*see Warnings and Precautions (5.17)*]
- Elevation of Cerebrospinal Fluid Pressure [*see Warnings and Precautions (5.18)*]
- Elevation of Intracholedochal Pressure [*see Warnings and Precautions (5.19)*]

6.1 Clinical Trials Experience

Because clinical trials are conducted under widely varying conditions, adverse reaction rates observed in the clinical trials of a drug cannot be directly compared to rates in the clinical trials of another drug and may not reflect the rates observed in practice.

The safety of BRIXADI was evaluated in 440 opioid-dependent patients across two, Phase 3 clinical studies: one double-blind, active-control (n=213) and one open-label (n=227). In these

studies, a total of 305 patients were exposed to BRIXADI for at least 24 weeks and 132 patients were exposed for at least 48 weeks.

In the first 12-week phase of the double-blind, double-dummy, active-controlled study, patients received BRIXADI (weekly) (16, 24, 32 mg) or matching placebo injections after a one-week titration. In the second 12-week phase of the study, patients remaining in the study received BRIXADI (monthly) (64, 96, 128, or 160 mg) or matching placebo injections. The 160 mg monthly dose is not an approved dose. Those randomized to receiving placebo injections were the active control groups and received sublingual buprenorphine/naloxone tablets at corresponding doses to BRIXADI. Patients receiving active BRIXADI injections also received placebo sublingual tablets.

Adverse reactions led to premature discontinuation in 10 (4.7%) patients in the group receiving BRIXADI compared to 5 (2.3%) patients in the sublingual buprenorphine/naloxone group, during the double-blind study.

Adverse reactions commonly reported after BRIXADI administration ($\geq 5\%$, regardless of dose and regimen) in the double-blind study, were injection site pain (9.9%), headache (7.5%), constipation (7.5%), nausea (7.0%), injection site erythema (6.6%), injection site pruritus (6.1%), Insomnia (5.6%), and urinary tract infection (5.2%).

Table 5 shows the adverse reactions for BRIXADI compared with the active-control group (SL BPN/NX) in the double-blind study.

Table 5: Adverse Reactions in the Phase 3 Double-Blind Study: $\geq 2\%$ of Patients Receiving BRIXADI (Excluding Injection Site Reactions).

| System Organ Class (SOC) Preferred Term (PT)^a | BRIXADI Total^b (N=213) n(%) | SL BPN/NX^c (N=215) n(%) |
|---|---|---|
| Cardiac disorders | 6 (2.8%) | 9 (4.2%) |
| Tachycardia | 5 (2.3) | 5 (2.3) |
| Gastrointestinal disorders | 43 (20.2%) | 45 (20.9%) |
| Constipation | 16 (7.5) | 16 (7.4) |
| Diarrhea | 6 (2.8) | 7 (3.3) |
| Nausea | 15 (7.0) | 17 (7.9) |
| Vomiting | 9 (4.2) | 8 (3.7) |
| Infections and infestations | 42 (19.7%) | 50 (23.3%) |
| Urinary tract infection | 11 (5.2) | 10 (4.7) |
| Upper respiratory tract infection | 9 (4.2) | 9 (4.2) |
| Musculoskeletal and connective tissue disorders | 20 (9.4%) | 22 (10.2%) |
| Arthralgia | 7 (3.3) | 3 (1.4) |
| Nervous system disorders | 27 (12.7%) | 27 (12.6%) |
| Headache | 16 (7.5) | 17 (7.9) |
| Psychiatric disorders | 20 (9.4%) | 20 (9.3%) |
| Anxiety | 6 (2.8) | 7 (3.3) |
| Insomnia | 12 (5.6) | 6 (2.8) |

a = report of adverse reactions that occurred in $\geq 2\%$ of the patients randomized to BRIXADI in Study HS-11-421. Patients are represented once per PT

b = This group includes all subjects exposed to varying doses of both the BRIXADI (weekly) and BRIXADI (monthly) formulations.

c = SL BPN/NX denotes the active comparator: patients assigned to daily buprenorphine with sham (placebo) injections. Patients randomized to this group could also receive a 'booster' injection of BRIXADI (weekly), 8mg, per protocol. All patients in Study 421 received a single test dose of 4mg SL BPN/NX before randomization into either arm.

Injection site reactions in the double-blind study are presented in Table 6 below. The majority of injection site-related adverse events were mild or moderate in severity. No injection site reactions were reported as severe intensity.

Table 6: Injection site reactions in the Double-Blind Phase 3 Study: $\geq 2\%$ of Patients Receiving BRIXADI

| Preferred Term (PT) ^a | BRIXADI Total ^b (N=213) n(%) | SL BPN/NX ^c (N=215) n(%) |
|--|---|---|
| Administration site reactions^d | 44 (20.7%) | 49 (22.8%) |
| Injection site pain | 21 (9.9%) | 17 (7.9%) |
| Injection site erythema | 14 (6.6%) | 12 (5.6%) |
| Injection site pruritus | 13 (6.1%) | 13 (6.0%) |
| Injection site swelling | 10 (4.7%) | 7 (3.3%) |
| Injection site reaction | 9 (4.2%) | 7 (3.3%) |

a = Injection site reactions (ISR) that occurred in $\geq 2\%$ of patients receiving BRIXADI, in the controlled trial, HS-11-421. Patients are represented once per PT.

b = This group includes patients exposed to varying doses of both the BRIXADI weekly and monthly formulations.

c = SL BPN/NX denotes the active comparator: subjects assigned to daily buprenorphine with sham (placebo) injections. Patients randomized to this group could also receive a supplemental ‘booster’ injection of BRIXADI (weekly), 8mg, per protocol.

d = The ISRs that occurred in $\geq 2\%$ of the patients randomized to BRIXADI were reported under the HGLT of Administration site reactions. However, ISRs were also identified under the Bacterial infectious disorders HGLT (of which, there were three injection site related cellulitis reactions in the BRIXADI group and one in the SL BPN/NX group, respectively) but those numbers did not rise to level of reporting. Tabulation included all events coded as treatment emergent *and* injection site reactions, regardless of treatment emergent flags.

6.2 Postmarketing Experience

The following adverse reactions have been identified during post-approval use of buprenorphine. Because these reactions are reported voluntarily from a population of uncertain size, it is not always possible to reliably estimate their frequency or establish a causal relationship to drug exposure.

The most frequently reported postmarketing adverse event observed with buprenorphine sublingual tablets, excluding drug exposure during pregnancy, was drug misuse or abuse.

Serotonin syndrome: Cases of serotonin syndrome, a potentially life-threatening condition, have been reported during concomitant use of opioids with serotonergic drugs.

Adrenal insufficiency: Cases of adrenal insufficiency have been reported with opioid use, more often following greater than one month of use.

Anaphylaxis: Anaphylaxis has been reported with buprenorphine [see *Contraindications (4)*].

Androgen deficiency: Cases of androgen deficiency have occurred with chronic use of opioids [see *Clinical Pharmacology (12.2)*].

The following adverse reactions have been identified during post-approval use of an identical buprenorphine extended-release injection for subcutaneous use outside of the United States and are not described elsewhere in the label. Because these reactions are reported voluntarily from a population of uncertain size, it is not always possible to reliably estimate their frequency or establish a causal relationship to drug exposure.

Injection site mass: Cases of injection site mass have been reported after treatment initiation.

Injection site abscess, ulceration, and necrosis: Cases of injection site abscess, ulceration and necrosis have been reported after treatment initiation.

Insufficient dosing: Cases of drug withdrawal reactions consistent with insufficient drug dosing have been reported, often occurring at or after two weeks of treatment initiation and resolving upon dose increase.

7 DRUG INTERACTIONS

| Benzodiazepines and other Central Nervous System (CNS) Depressants | |
|---|---|
| Clinical Impact: | Due to additive pharmacologic effects, the concomitant use of benzodiazepines or other CNS depressants, including alcohol, increases the risk of respiratory depression, profound sedation, coma, and death. |
| Intervention: | <p>Cessation of benzodiazepines or other CNS depressants is preferred in most cases of concomitant use. In some cases, monitoring in a higher level of care for taper may be appropriate. In others, gradually tapering a patient off a prescribed benzodiazepine or CNS depressant or decreasing to the lowest effective dose may be appropriate. Similarly, cessation of other CNS depressants is preferred when possible.</p> <p>Before co-prescribing benzodiazepines for anxiety or insomnia, ensure that patients are appropriately diagnosed and consider alternative medications and non-pharmacologic treatment [see <i>Warnings and Precautions (5.5)</i>].</p> <p>If concomitant use is warranted, strongly consider prescribing naloxone for the emergency treatment of opioid overdose, as is recommended for all patients in treatment for opioid use disorder [see <i>Warnings and Precautions (5.4)</i>].</p> |
| Examples: | Alcohol, non-benzodiazepine sedatives/hypnotics, anxiolytics, tranquilizers, muscle relaxants, general anesthetics, antipsychotics, and other opioids. |
| Inhibitors of CYP3A4 | |
| Clinical Impact: | <p>The effects on buprenorphine exposure in patients treated with BRIXADI have not been studied, and the effects may be dependent on the route of administration.</p> <p>Buprenorphine is metabolized to norbuprenorphine primarily by CYP3A4; therefore, potential interactions may occur when BRIXADI is given concurrently with agents that affect CYP3A4 activity [see <i>Clinical Pharmacology (12.3)</i>].</p> |

| | |
|------------------------|---|
| | <p>The concomitant use of buprenorphine and CYP3A4 inhibitors can increase the plasma concentration of buprenorphine, resulting in increased or prolonged opioid effects, particularly when an inhibitor is added after a stable dose of BRIXADI is achieved.</p> |
| Intervention: | <p><u>Patients Converted to BRIXADI Treatment from a Regimen of Transmucosal Buprenorphine used Concomitantly with CYP3A4 Inhibitors:</u> Monitor to ensure that the plasma buprenorphine level provided by BRIXADI is adequate.</p> <p><u>Patients Already on BRIXADI who Require Newly-Initiated Treatment with a CYP3A4 Inhibitor:</u> Monitor for signs and symptoms of over-medication. If signs and symptoms of buprenorphine toxicity or overdose occur but the concomitant medication cannot be reduced or discontinued, reduce the dose of BRIXADI. If available doses do not permit achievement of the desired dose, it may be necessary to discontinue treatment with BRIXADI and treat the patient with a formulation of buprenorphine that permits more precise dose adjustments.</p> <p><u>Patients Stabilized on BRIXADI in the Setting of Concomitant Medication That is a CYP3A4 Inhibitor, and the Concomitant Medication is Discontinued:</u> Monitor for withdrawal and consider a dosage adjustment of BRIXADI. If the dose of BRIXADI cannot be adjusted to an adequate level in the absence of the concomitant medication, transition the patient back to a formulation of buprenorphine that permits more precise dose adjustments.</p> |
| Examples: | <p>azole antifungals (e.g., ketoconazole), macrolide antibiotics (e.g., erythromycin), and protease inhibitors (e.g., ritonavir, indinavir, and saquinavir)</p> |
| CYP3A4 Inducers | |
| Clinical Impact: | <p>The effects of co-administered CYP3A4 inducers on buprenorphine exposure in patients treated with BRIXADI have not been studied.</p> <p>Buprenorphine is metabolized to norbuprenorphine primarily by CYP3A4; therefore, potential interactions may occur when BRIXADI is given concurrently with agents that affect CYP3A4 activity [<i>see Clinical Pharmacology (12.3)</i>].</p> <p>CYP3A4 inducers may induce metabolism of buprenorphine and, therefore, may cause increased clearance of the drug which could lead to a decrease in buprenorphine plasma concentrations, lack of efficacy or, possibly, development of an abstinence syndrome.</p> |
| Intervention: | <p><u>Patients Converted to BRIXADI Treatment from a Regimen of Transmucosal Buprenorphine used Concomitantly with CYP3A4 Inducers:</u> Monitor to ensure that the plasma buprenorphine level provided by BRIXADI is adequate.</p> <p><u>Patients Already on BRIXADI who Require Newly-Initiated Treatment with a CYP3A4 Inducer:</u> Monitor for withdrawal. If the</p> |

| | |
|--|--|
| | <p>dose of BRIXADI is not adequate in the presence of the concomitant medication, and the concomitant medication cannot be reduced or discontinued, adjust the dose of BRIXADI. If the dose of BRIXADI cannot be adjusted to an adequate level, transition the patient back to a formulation of buprenorphine that permits more precise dose adjustments.</p> <p><u>Patients Stabilized on BRIXADI in the setting of Concomitant Medication that is a CYP3A4 Inducer, and the Concomitant Medication is Discontinued:</u> Monitor for signs and symptoms of over-medication. If the dose provided by BRIXADI is excessive in the absence of the concomitant inducer, consider reducing the dose of BRIXADI.</p> <p>If the dose of BRIXADI cannot be adjusted to an adequate level, transition the patient back to a formulation of buprenorphine that permits more precise dose adjustments [see <i>Clinical Pharmacology (12.3)</i>].</p> |
| Examples: | Rifampin, carbamazepine, phenytoin, phenobarbital |
| Antiretrovirals: Non-nucleoside reverse transcriptase inhibitors (NNRTIs) | |
| Clinical Impact: | Non-nucleoside reverse transcriptase inhibitors (NNRTIs) are metabolized principally by CYP3A4. Efavirenz, nevirapine, and etravirine are known CYP3A4 inducers, whereas delavirdine is a CYP3A4 inhibitor. Significant pharmacokinetic interactions between NNRTIs (e.g., efavirenz and delviradine) and buprenorphine have been shown in clinical studies, but these pharmacokinetic interactions did not result in any significant pharmacodynamics effects. |
| Intervention: | It is recommended that patients who are on BRIXADI treatment have their dose monitored for increase or decrease in therapeutic effects if NNRTIs are added to their treatment regimen. |
| Examples: | Efavirenz, nevirapine, etravirine, delavirdine |
| Antiretrovirals: Protease Inhibitors (PIs) | |
| Clinical Impact: | Studies have shown some antiretroviral protease inhibitors (PIs) with CYP3A4 inhibitory activity (e.g., nelfinavir, lopinavir/ritonavir, ritonavir) have little effect on buprenorphine pharmacokinetics and no significant pharmacodynamics effects. Other PIs with CYP3A4 inhibitory activity (e.g., atazanavir and atazanavir/ritonavir) resulted in elevated levels of buprenorphine and norbuprenorphine and patients in one study reported increased sedation. Symptoms of opioid excess have been found in postmarketing reports of patients receiving buprenorphine and atazanavir with and without ritonavir concomitantly. |
| Intervention: | If treatment with atazanavir with and without ritonavir must be initiated in a patient already treated with BRIXADI, the patient should be monitored for signs and symptoms of over-medication. It may be necessary to discontinue treatment with BRIXADI and treat the patient with a sublingual buprenorphine product that permits rapid dose adjustments. |

| | |
|---|---|
| Examples: | Atazanavir, ritonavir |
| Antiretrovirals: Nucleoside reverse transcriptase inhibitors (NRTIs) | |
| Clinical impact: | Nucleoside reverse transcriptase inhibitors (NRTIs) do not appear to induce or inhibit the P450 enzyme pathway, thus no interactions with buprenorphine are expected. |
| Intervention: | None |
| Serotonergic Drugs | |
| Clinical Impact: | The concomitant use of opioids with other drugs that affect the serotonergic neurotransmitter system has resulted in serotonin syndrome. |
| Intervention: | If concomitant use is warranted, carefully observe the patient, particularly during treatment initiation, and during dose adjustment of the serotonergic drug. Discontinue BRIXADI if serotonin syndrome is suspected. |
| Examples: | Selective serotonin reuptake inhibitors (SSRIs), serotonin and norepinephrine reuptake inhibitors (SNRIs), tricyclic antidepressants (TCAs), triptans, 5-HT ₃ receptor antagonists, drugs that affect serotonin neurotransmitter system (e.g., mirtazapine, trazodone, tramadol), certain muscle relaxants (i.e. cyclobenzaprine, metaxalone), and monoamine oxidase (MAO) inhibitors (those intended to treat psychiatric disorders and also others, such as linezolid and intravenous methylene blue). |
| Monoamine Oxidase Inhibitors (MAOIs) | |
| Clinical Impact: | MAOI interactions with opioids may manifest as serotonin syndrome or opioid toxicity (e.g., respiratory depression, coma). |
| Intervention: | The use of BRIXADI is not recommended for patients taking MAOIs or within 14 days of stopping such treatment. |
| Examples: | Phenelzine, tranylcypromine, linezolid |
| Muscle Relaxants | |
| Clinical Impact: | Buprenorphine may enhance the neuromuscular blocking action of skeletal muscle relaxants and produce an increased degree of respiratory depression. |
| Intervention: | Monitor patients receiving muscle relaxants and BRIXADI for signs of respiratory depression that may be greater than otherwise expected and decrease the dosage of the muscle relaxant as necessary. Due to the risk of respiratory depression with concomitant use of skeletal muscle relaxants and opioids, strongly consider prescribing naloxone for the emergency treatment of opioid overdose [<i>see Dosage and Administration (2.3), Warnings and Precautions (5.4, 5.5)</i>]. |
| Diuretics | |
| Clinical Impact: | Opioids can reduce the efficacy of diuretics by inducing the release of antidiuretic hormone. |
| Intervention: | Monitor patients for signs of diminished diuresis and/or effects on blood pressure and increase the dosage of the diuretic needed. |

| Anticholinergic Drugs | |
|------------------------------|--|
| Clinical Impact: | The concomitant use of anticholinergic drugs may increase the risk of urinary retention and/or severe constipation, which may lead to paralytic ileus. |
| Intervention: | Monitor patients for signs of urinary retention or reduced gastric motility when BRIXADI is used concomitantly with anticholinergic drugs. |

8 USE IN SPECIFIC POPULATIONS

8.1 Pregnancy

Risk Summary

The data on use of buprenorphine, the active ingredient in BRIXADI in pregnancy, are limited; however, these data do not indicate an increased risk of major malformations specifically due to buprenorphine exposure. There are limited data from randomized clinical trials in women maintained on sublingual buprenorphine that were not designed appropriately to assess the risk of major malformations [see Data].

Embryofetal death was observed in both rats and rabbits administered buprenorphine during the period of organogenesis at doses 21 times and equal to, respectively, the mean daily dose of 4.6 mg buprenorphine delivered by either 32 mg BRIXADI (weekly) or 128 mg BRIXADI (monthly). Pre- and post-natal development studies in rats demonstrated increased neonatal deaths at doses approximately equal to and above and dystocia at 11 times the mean daily dose of 4.6 mg buprenorphine. No clear teratogenic effects were seen when buprenorphine was administered during organogenesis with a range of doses 4 times and greater than the mean daily dose of 4.6 mg of buprenorphine. However, increases in skeletal abnormalities were noted in rats and rabbits administered buprenorphine daily during organogenesis at doses 2 and 21 times the mean daily dose of 4.6 mg of buprenorphine, respectively. In a few studies, some events such as acephalus and omphalocele were also observed but these findings were not clearly treatment-related [see Data]. Based on animal data, advise pregnant women of the potential risk to a fetus.

The estimated background risk of major birth defects and miscarriage for the indicated population are unknown. In the U.S. general population, the estimated background risk of major birth defects and miscarriage in clinically recognized pregnancies is 2-4% and 15-20%, respectively.

Clinical Considerations

Disease-associated maternal and embryo-fetal risk

Untreated opioid addiction in pregnancy is associated with adverse obstetrical outcomes such as low birth weight, preterm birth, and fetal death. In addition, untreated opioid addiction often results in continued or relapsing illicit opioid use.

Dose Adjustment during Pregnancy and the Postpartum Period

Dosage adjustments of buprenorphine may be required during pregnancy, even if the patient was maintained on a stable dose prior to pregnancy. Withdrawal signs and symptoms should be monitored closely, and the dose adjusted as necessary.

Fetal/neonatal adverse reactions

Neonatal opioid withdrawal syndrome may occur in newborn infants of mothers who are receiving treatment with BRIXADI.

Neonatal opioid withdrawal syndrome presents as irritability, hyperactivity, and abnormal sleep pattern, high pitched cry, tremor, vomiting, diarrhea, and/or failure to gain weight. Signs of neonatal withdrawal usually occur in the first days after birth. The duration and severity of neonatal opioid withdrawal syndrome may vary. Observe newborns for signs of neonatal opioid withdrawal syndrome and manage accordingly [see *Warnings and Precautions (5.6)*].

Labor or Delivery

Opioid-dependent women on buprenorphine maintenance therapy may require additional analgesia during labor.

As with all opioids, use of buprenorphine prior to delivery may result in respiratory depression in the newborn. Closely monitor neonates for signs of respiratory depression. An opioid antagonist such as naloxone should be available for reversal of opioid induced respiratory depression in the neonate.

Data

Human Data

Studies have been conducted to evaluate neonatal outcomes in women exposed to buprenorphine during pregnancy. Limited data from trials, observational studies, case series, and case reports on buprenorphine use in pregnancy do not indicate an increased risk of major malformations specifically due to buprenorphine. Several factors may complicate the interpretation of investigations of the children of women who take buprenorphine during pregnancy, including maternal use of illicit drugs, late presentation for prenatal care, infection, poor compliance, poor nutrition, and psychosocial circumstances. Interpretation of data is complicated further by the lack of information on untreated opioid-dependent pregnant women, who would be the most appropriate group for comparison. Rather, women on another form of opioid medication-assisted treatment, or women in the general population are generally used as the comparison group. However, women in these comparison groups may be different from women prescribed buprenorphine-containing products with respect to maternal factors that may lead to poor pregnancy outcomes.

In a multicenter, double-blind, randomized, controlled trial (Maternal Opioid Treatment: Human Experimental Research [MOTHER]) designed primarily to assess neonatal opioid withdrawal effects, opioid-dependent pregnant women were randomized to buprenorphine (n=86) or methadone (n=89) treatment, with enrollment at an average gestational age of 18.7 weeks in both groups. A total of 28 of the 86 women in the buprenorphine group (33%) and 16 of the 89 women in the methadone group (18%) discontinued treatment before the end of pregnancy.

Among women who remained in treatment until delivery, there was no difference between buprenorphine-treated and methadone-treated groups in the number of neonates requiring NOWS treatment or in the peak severity of NOWS. Buprenorphine-exposed neonates required less morphine (mean total dose, 1.1 mg vs 10.4 mg), had shorter hospital stays (10.0 days vs 17.5 days), and shorter duration of treatment for NOWS (4.1 days vs 9.9 days) compared to the methadone-exposed group. There were no differences between groups in other primary outcomes (neonatal head circumference) or secondary outcomes (weight and length at birth, preterm birth,

gestational age at delivery, and 1-minute and 5-minute Apgar scores), or in the rates of maternal or neonatal adverse events. The outcomes among mothers who discontinued treatment before delivery and may have relapsed to illicit opioid use are not known. Because of the imbalance in discontinuation rates between the buprenorphine and methadone groups, the study findings are difficult to interpret.

Animal Data

The exposure margins below are based on the mean daily dose of 4.6 mg buprenorphine delivered by 32 mg BRIXADI (weekly) or 128 mg BRIXADI (monthly) on body surface area comparisons, unless otherwise noted.

No definitive drug-related teratogenic effects were observed in rats and rabbits at IM doses up to 30 mg/kg/day (64 times and 127 times, respectively, on a mg/m² basis). Maternal toxicity resulting in mortality was noted in these studies in both rats and rabbits. Acephalus was observed in one rabbit fetus from the low-dose group and omphalocele was observed in two rabbit fetuses from the same litter in the mid-dose group; no findings were observed in fetuses from the high-dose group. Maternal toxicity was seen in the high-dose group but not at the lower doses where the findings were observed. Following oral administration of buprenorphine to rats, dose-related post-implantation losses, evidenced by increases in the numbers of early resorptions with consequent reductions in the numbers of fetuses, were observed at doses of 10 mg/kg/day or greater (21 times on a mg/m² basis). In the rabbit, increased post-implantation losses occurred at an oral dose of 40 mg/kg/day (169 times on a mg/m² basis). Following IM administration in the rat and the rabbit, post-implantation losses, as evidenced by decreases in live fetuses and increases in resorptions, occurred at 30 mg/kg/day (64 times and 127 times, respectively, on a mg/m² basis).

Buprenorphine was not teratogenic in rats and rabbits after subcutaneous (SC) doses of up to 5 mg/kg/day (9 and 5 times in rat, and 12 and 7 times in rabbit the highest daily exposure from 32 mg BRIXADI (weekly) or 128 mg BRIXADI (monthly), respectively, on an AUC basis), after intramuscular (IM) doses of up to 5 mg/kg/day (11 and 21 times on a mg/m² basis), after IV doses up to 0.8 mg/kg/day (2 and 3 times on a mg/m² basis), or after oral doses up to 160 mg/kg/day in rats (338 times on a mg/m² basis) and 25 mg/kg/day in rabbits (106 times on a mg/m² basis). Significant increases in skeletal abnormalities (e.g., extra thoracic vertebra or thoraco-lumbar ribs) were noted in rats after SC administration of 1 mg/kg/day and up (2.4 or 1.5 times the highest daily exposure from 32 mg BRIXADI (weekly) or 128 mg BRIXADI (monthly), respectively, on an AUC basis, but were not observed at oral doses up to 160 mg/kg/day (338 times on a mg/m² basis).

Increases in skeletal abnormalities in rabbits after IM administration of 5 mg/kg/day (21 times on a mg/m² basis) in the absence of maternal toxicity or oral administration of 1 mg/kg/day or greater (4 times on a mg/m² basis) were not statistically significant. In rabbits, buprenorphine produced statistically significant pre-implantation losses at oral doses of 1 mg/kg/day or greater (4 times on a mg/m² basis) and post-implantation losses that were statistically significant at IV doses of 0.2 mg/kg/day or greater (approximately equal on a mg/m² basis). No maternal toxicity was noted at doses causing post-implantation loss in this study.

Dystocia was noted in pregnant rats treated intramuscularly with buprenorphine from Gestation Day 14 through Lactation Day 21 at 5 mg/kg/day (11 times on a mg/m² basis). Fertility and pre- and post-natal development studies with buprenorphine in rats indicated increases in neonatal mortality after oral doses of 0.8 mg/kg/day and up (2 times on a mg/m² basis), after IM doses of

0.5 mg/kg/day and up (approximately equal on a mg/m² basis), and after SC doses of 0.1 mg/kg/day and up (0.4 or 0.3 times the highest daily exposure from 32 mg BRIXADI (weekly) or 128 mg BRIXADI (monthly), respectively, on an AUC basis). An apparent lack of milk production during these studies likely contributed to the decreased pup viability and lactation indices. Delays in the occurrence of righting reflex and startle response were noted in rat pups at an oral dose of 80 mg/kg/day (169 times on a mg/m² basis).

8.2 Lactation

Risk Summary

Based on two studies in 13 lactating women maintained on sublingual buprenorphine treatment, buprenorphine and its metabolite norbuprenorphine were present in low levels in human milk. Available data have not shown adverse reactions in breastfed infants. The development and health benefits of breastfeeding should be considered along with the mother's clinical need for buprenorphine treatment and any potential adverse effects on the breastfed child from the drug or from the underlying maternal condition.

Clinical Considerations

Advise the nursing mother taking buprenorphine to monitor the infant for increased drowsiness and breathing difficulties.

Data

Data were consistent from two studies (N=13) of breastfeeding infants whose mothers were maintained on sublingual doses of buprenorphine ranging from 2.4 to 24 mg/day, showing that the infants were exposed to less than 1% of the maternal daily dose.

In a study of six lactating women who were taking a median sublingual buprenorphine dose of 0.29 mg/kg/day 5 to 8 days after delivery, breast milk provided a median infant dose of 0.42 mcg/kg/day of buprenorphine and 0.33 mcg/kg/day of norbuprenorphine, equal to 0.2% and 0.12% respectively, of the maternal weight-adjusted dose (relative dose/kg [%] of norbuprenorphine was calculated from the assumption that buprenorphine and norbuprenorphine are equipotent).

Data from a study of seven lactating women who were taking a median (sublingual buprenorphine) dose of 7 mg/day an average of 1.12 months after delivery indicated that the mean milk concentrations (C_{avg}) of buprenorphine and norbuprenorphine were 3.65 mcg/L and 1.94 mcg/L respectively. Based on the study data, and assuming milk consumption of 150 mL/kg/day, an exclusively breastfed infant would receive an estimated mean absolute infant dose (AID) of 0.55 mcg/kg/day of buprenorphine and 0.29 mcg/kg/day of norbuprenorphine, or a mean relative infant dose (RID) of 0.38% and 0.18%, respectively, of the maternal weight-adjusted dose.

8.3 Females and Males of Reproductive Potential

Infertility

Chronic use of opioids may cause reduced fertility in females and males of reproductive potential. It is not known whether these effects on fertility are reversible [see *Adverse Reactions (6.2), Clinical Pharmacology (12.2), Nonclinical Toxicology (13.1)*].

8.4 Pediatric Use

The safety and effectiveness of BRIXADI have not been established in pediatric patients.

8.5 Geriatric Use

Clinical studies of BRIXADI did not include sufficient numbers of subjects aged 65 or older to determine whether they respond differently to the drug than younger patients. Other reported clinical experience with buprenorphine has not identified differences in responses between the geriatric and younger patients.

Due to possible decreased hepatic, renal, or cardiac function and of concomitant disease or other drug therapy in geriatric patients, the decision to prescribe BRIXADI should be made cautiously in individuals 65 years of age or older and these patients should be monitored for signs and symptoms of toxicity or overdose.

8.6 Hepatic Impairment

The effect of hepatic impairment on the pharmacokinetics of BRIXADI has not been studied.

The effect of hepatic impairment on the pharmacokinetics of sublingual buprenorphine has been evaluated in a pharmacokinetic study. While no clinically significant changes were observed in subjects with mild hepatic impairment, the plasma levels have been shown to be higher and half-life values have been shown to be longer for buprenorphine in subjects with moderate and severe hepatic impairment.

Because of the long-acting nature of the product, adjustments to dosages of BRIXADI are not rapidly reflected in plasma buprenorphine levels. Therefore, patients with pre-existing moderate to severe hepatic impairment are not candidates for treatment with BRIXADI.

Patients who develop moderate to severe hepatic impairment while being treated with BRIXADI should be monitored for signs and symptoms of toxicity or overdose caused by increased levels of buprenorphine [see *Warnings and Precautions (5.14), Clinical Pharmacology (12.3)*].

8.7 Renal Impairment

Clinical studies of BRIXADI did not include subjects with renal impairment. No differences in buprenorphine pharmacokinetics were observed between 9 dialysis-dependent and 6 normal patients following IV administration of 0.3 mg buprenorphine.

9 DRUG ABUSE AND DEPENDENCE

9.1 Controlled Substance

BRIXADI contains buprenorphine, a Schedule III substance under the Controlled Substances Act.

Under the Drug Addiction Treatment Act (DATA) codified at 21 U.S.C. 823(g), prescription use of this product in the treatment of opioid dependence is limited to healthcare providers who meet certain qualifying requirements, and who have notified the Secretary of Health and Human Services (HHS) of their intent to prescribe this product for the treatment of opioid dependence and have been assigned a unique identification number that must be included on every prescription.

9.2 Abuse

Abuse is the intentional, non-therapeutic use of a drug, even once, for its desirable psychological or physiological effects. Misuse is the intentional use, for therapeutic purposes, of a drug by an individual in a way other than prescribed by a healthcare provider or for whom it was not prescribed.

BRIXADI contains buprenorphine, a Schedule III controlled substance that can be abused similar to other opioids. Patients who continue to misuse, abuse, or divert buprenorphine products or other opioids should be provided with or referred for more intensive and structured treatment. Abuse of buprenorphine poses a risk of overdose and death. This risk is increased with the abuse of buprenorphine and alcohol and other substances, especially benzodiazepines [*see Warnings and Precautions (5.5)*].

BRIXADI is distributed through a restricted distribution program, which is intended to prevent the direct distribution to a patient. BRIXADI should only be dispensed directly to a healthcare provider for administration by a healthcare provider. It is supplied in prefilled syringes and is intended for administration only by subcutaneous injection by a healthcare provider. The entire contents of the prefilled syringe should be administered. After administration, a small amount of BRIXADI may remain in the needle and syringe should be properly disposed of [*see How Supplied/Storage and Handling (16)*].

Upon injection, BRIXADI spontaneously transforms from a low viscous solution to a liquid crystalline gel that encapsulates buprenorphine and releases it at a steady rate as the depot biodegrades [*see Warnings and Precautions (5.1)*]. Clinical monitoring for evidence at the injection site of tampering or attempting to remove the depot should be ongoing throughout treatment. No attempts to remove BRIXADI have been reported in clinical trials.

9.3 Dependence

Physical dependence is a state that develops as a result of physiological adaptation in response to repeated drug use, manifested by withdrawal signs and symptoms after abrupt discontinuation or a significant dose reduction of a drug.

Buprenorphine is a partial agonist at the mu-opioid receptor and chronic administration produces physical dependence of the opioid type, characterized by moderate withdrawal signs and symptoms upon abrupt discontinuation or rapid taper. The withdrawal syndrome is typically milder than seen with full agonists and may be delayed in onset. Monitor patients during

discontinuation of BRIXADI for symptoms of withdrawal [*see Warnings and Precautions (5.8)*].

Due to the long-acting nature of BRIXADI, withdrawal signs and symptoms may not be evident immediately following the discontinuation of treatment.

Neonatal opioid withdrawal syndrome (NOWS) is an expected and treatable outcome of prolonged use of opioids during pregnancy [*see Warnings and Precautions (5.6)*].

10 OVERDOSAGE

Clinical Presentation

The manifestations of acute buprenorphine overdose include pinpoint pupils, sedation, hypotension, respiratory depression, and death.

Treatment of Overdose

In the event of overdose, the respiratory and cardiac status of the patient should be monitored carefully. When respiratory or cardiac functions are depressed, primary attention should be given to the re-establishment of adequate respiratory exchange through provision of a patent airway and institution of assisted or controlled ventilation. Oxygen, IV fluids, vasopressors, and other supportive measures should be considered as indicated. Naloxone may be of value for the management of buprenorphine overdose. Higher than normal doses and repeated administration may be necessary.

Clinicians should consider the potential role and contribution of buprenorphine, other opioids, and other CNS depressant drugs in a patient's clinical presentation.

11 DESCRIPTION

BRIXADI (buprenorphine) extended-release injection is a sterile, yellowish to yellow clear liquid provided in a single-dose, pre-filled syringe intended for subcutaneous injection only. BRIXADI is designed to deliver buprenorphine at a controlled rate over either one week or one month.

The active ingredient in BRIXADI is buprenorphine free base, a partial opioid agonist.

BRIXADI is provided in multiple doses with two durations (weekly and monthly).

- BRIXADI (weekly; 8, 16, 24, 32 mg) consists of 50 mg/mL buprenorphine base, 10% w/w anhydrous ethanol and soybean phosphatidylcholine/glycerol dioleate in a weight ratio 50/50 to final volume.
- BRIXADI (monthly; 64, 96, 128 mg) consists of 356 mg/mL buprenorphine base, 30% w/w N-methyl pyrrolidine and soybean phosphatidylcholine/glycerol dioleate in weight ratio 40/60 to final volume.

Upon injection, BRIXADI spontaneously transforms from a low viscous solution to a liquid crystalline gel that encapsulates buprenorphine and releases it at a steady rate as the depot biodegrades.

Different drug product strengths, or doses, are accomplished by different syringe fill volumes [see *Dosage Forms and Strengths (3)*].

The molecular weight of buprenorphine free base is 467.65 g/mol, and its molecular formula is C₂₉H₄₁NO₄. Chemically, buprenorphine is: (2S)-2-[17-(Cyclopropylmethyl)-4,5 α -epoxy-3-hydroxy-6 α ,14-ethano-14 α -morphinan-7 α -yl]-3,3-dimethylbutan-2-ol.

The structural formula is:

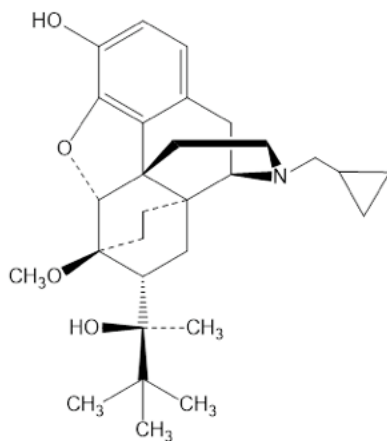

12 CLINICAL PHARMACOLOGY

12.1 Mechanism of Action

BRIXADI contains buprenorphine, a partial agonist at the mu-opioid receptor and an antagonist at the kappa-opioid receptor.

12.2 Pharmacodynamics

Opioid Blockade

The opioid blockade study assessed the blockade of subjective opioid drug-liking effects and pharmacokinetics (PK) of BRIXADI (weekly) in 47 patients with moderate or severe opioid dependence. The primary endpoint was the maximum rating (E_{max}) on the visual analogue scale (VAS) for drug-liking. After stabilization on immediate-release morphine, all patients completed a 3-day qualification/baseline hydromorphone challenge session consisting of 3 intramuscular

doses of hydromorphone (0 mg, [placebo], 6 mg, and 18 mg) once daily for 3 consecutive days in a randomized, double-blind, crossover manner. Following the qualification phase, eligible patients received 2 injections of BRIXADI (weekly) for two weeks at either the 24 mg or 32 mg level. Two hydromorphone challenge sessions (3 consecutive days each) were conducted throughout the week after each weekly injection of BRIXADI (weekly).

On average, the subjective effects (e.g., drug liking [E_{max}]) of 6 mg or 18 mg hydromorphone was blocked following injections of BRIXADI (weekly) at the 24 mg or 32 mg levels. The variability in drug-liking scores was wider for the 18 mg than the 6 mg hydromorphone dose level. In addition, for the 18 mg hydromorphone dose challenge, the drug-liking score variability was wider towards the end of the BRIXADI (weekly) dosing interval compared to earlier in the interval (e.g. Days 4-6 versus Days 1-3; Day 11-13 versus Day 8-10). Drug-liking score variability was wider for the 24 mg BRIXADI (weekly) dose level compared to 32 mg [*see Clinical Studies (14.1)*].

Figure 14 illustrates the relationship between buprenorphine plasma level and drug liking after 18 mg hydromorphone where data from the 24 mg BRIXADI (weekly) arm is pooled with data from the 32 mg BRIXADI (weekly) arm. The observed plateau for maximal response of drug-liking was reached at buprenorphine concentrations of approximately 1.5-2 ng/mL plasma levels.

Figure 14: Placebo-Corrected Drug Liking VAS vs. Plasma Buprenorphine Concentration Following 18 mg Hydromorphone Challenges for Pooled 24 mg and 32 mg Arms

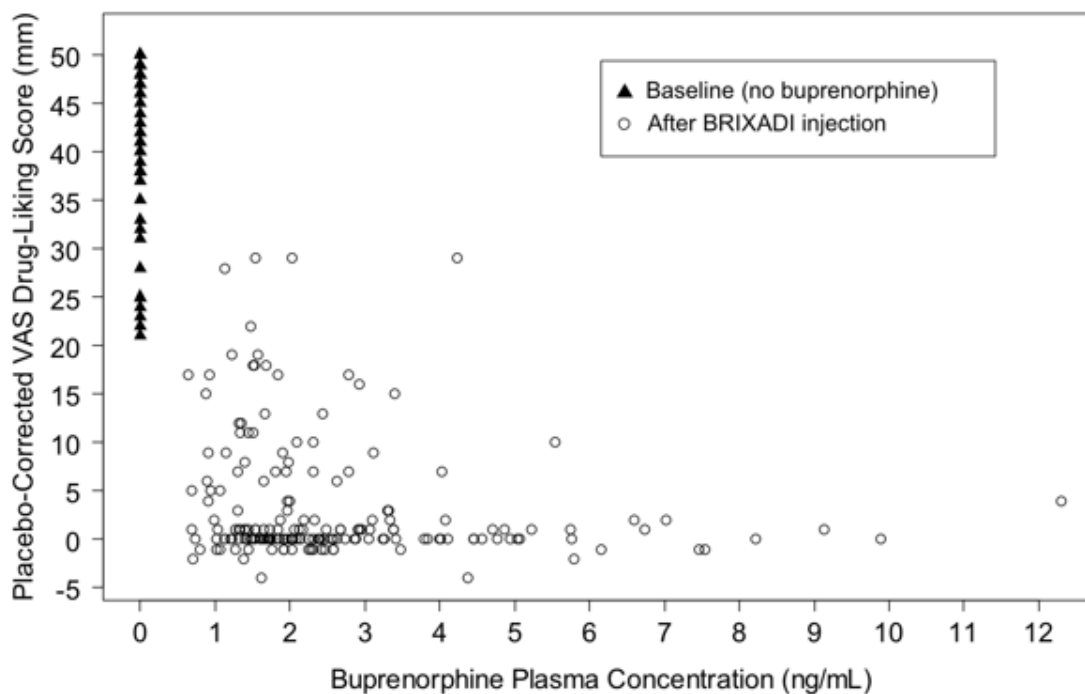

Androgen Deficiency

Chronic use of opioids may influence the hypothalamic-pituitary-gonadal axis, leading to androgen deficiency that may manifest as low libido, impotence, erectile dysfunction, amenorrhea, or infertility.

The causal role of opioids in the clinical syndrome of hypogonadism is unknown because the various medical, physical, lifestyle, and psychological stressors that may influence gonadal

hormone levels have not been adequately controlled for in studies conducted to date. Patients presenting with symptoms of androgen deficiency should undergo laboratory evaluation.

Cardiac Electrophysiology

Thorough QT studies with buprenorphine products have demonstrated modest QT prolongation ≤ 15 msec. Two categorical analyses of cardiovascular-specific adverse events among patients exposed to buprenorphine demonstrated no proarrhythmic potential. One Holter monitoring study demonstrated no arrhythmia. An analysis of medical literature provided no evidence for causal association between buprenorphine and Torsades de Pointes.

Physiological Effects

Buprenorphine in IV (2, 4, 8, 12 and 16 mg) and sublingual (12 mg) doses have been administered to opioid-experienced subjects who were not physically dependent to examine cardiovascular, respiratory, and subjective effects at doses comparable to those used for treatment of opioid use disorder. Compared to placebo, there were no statistically significant differences among any of the treatment conditions for blood pressure, heart rate, respiratory rate, O₂ saturation, or skin temperature across time. Systolic BP was higher in the 8 mg group than placebo (3-hour AUC values). Minimum and maximum effects were similar across all treatments. Subjects remained responsive to low voice and responded to computer prompts. Some subjects showed irritability, but no other changes were observed.

The respiratory effects of sublingual buprenorphine were compared with the effects of methadone in a double-blind, parallel group, dose ranging comparison of single doses of buprenorphine sublingual solution (1, 2, 4, 8, 16, or 32 mg) and oral methadone (15, 30, 45, or 60 mg) in non-dependent, opioid-experienced volunteers. In this study, hypoventilation not requiring medical intervention was reported more frequently after buprenorphine doses of 4 mg and higher than after methadone. Both drugs decreased O₂ saturation to the same degree.

In clinical studies conducted with BRIXADI at doses ranging from 7.5 to 32 mg for weekly BRIXADI and 64 to 192 mg for monthly BRIXADI, no incidences of temperature elevations, or clinically significant lowering of oxygen saturation were observed.

12.3 Pharmacokinetics

Absorption

BRIXADI is an extended-release formulation of buprenorphine designed for subcutaneous administration. BRIXADI is available in two regimens: weekly and monthly. Following single doses of BRIXADI (weekly) or BRIXADI (monthly), the buprenorphine C_{max} and AUC_{inf} increase dose-proportionally.

The steady-state PK of buprenorphine following BRIXADI (weekly), BRIXADI (monthly) and their comparison to sublingual SUBUTEX across three studies are shown in Table 7. In these studies, BRIXADI (weekly) was administered for 4 or 4 to 7 weekly doses, BRIXADI (monthly) was administered for 4 monthly doses, and SUBUTEX was administered for 7 daily doses.

After BRIXADI subcutaneous injection, the buprenorphine plasma concentration increases with a median time to maximum plasma concentration (t_{max}) of about 24 hours for BRIXADI

(weekly) and 6-10 hours for BRIXADI (monthly). Based on trough levels after each dose, steady-state exposure is reached at administration of the fourth weekly or monthly dose.

After four repeated doses of BRIXADI (weekly) (16 mg) AUC_τ (0-7d), C_{max} and C_{trough} values are ~40% higher exposure compared to the first dose. Based on cross-study comparisons, four repeated doses of BRIXADI (monthly) (128 mg) results in 68%, 65%, and 124% higher AUC_τ (0-28d), C_{max} and C_{trough} values, respectively compared to the first dose.

Table 7: Summary of steady-state PK parameters of buprenorphine after subcutaneous buttock injections of BRIXADI (weekly) and BRIXADI (monthly) and sublingual (SL) administration of SUBUTEX

| Drug product dose | | | C _{av} (ng/mL) | | | C _{max} (ng/mL) | | | C _{trough} ^a (ng/mL) | | |
|-------------------|------------------|-------------------|-------------------------|------------------|-------------------|--------------------------|------------------|-------------------|--|------------------|-------------------|
| SL BPN | Brixadi (weekly) | Brixadi (monthly) | SL BPN * | Brixadi (weekly) | Brixadi (monthly) | SL BPN * | Brixadi (weekly) | Brixadi (monthly) | SL BPN * | Brixadi (weekly) | Brixadi (monthly) |
| 8 mg | 16 mg | 64 mg | 1.2 | 2.1 | 2.0 ^s | 4.7 | 4.3 | 4.0 ^s | 0.7 | 0.8 | 1.3 ^s |
| 16 mg | 24 mg | 96 mg | 1.8 | 2.9 ^s | 2.9 ^s | 6.5 | 5.5 ^s | 6.0 ^s | 1.0 | 1.4 ^s | 2.0 ^s |
| 24 mg | 32 mg | 128 mg | 2.5 | 4.2 | 3.9 | 8.2 | 6.9 | 11.1 | 1.4 | 2.6 | 2.1 |

* Average value of two studies

^s Simulated

^a C_{168h} after 4th dose for BRIXADI (weekly), C_{28d} after 4th dose for BRIXADI (monthly) and C_{24h} after 7th daily dose for Subutex

Effect of injection Site on PK of BRIXADI

After multiple dose subcutaneous injections of 32 mg BRIXADI weekly product at different injection sites (abdomen, thigh, buttock or upper arm), a comparable PK exposure was observed. However, injection in the arm site was associated with approximately 10% lower plasma levels than other sites.

Distribution:

Buprenorphine is approximately 96% protein bound, primarily to alpha and beta globulin.

Elimination:

Buprenorphine is metabolized and eliminated in urine and feces. The apparent terminal plasma half-life of buprenorphine following subcutaneous injection of BRIXADI ranged between 3 to 5 days for BRIXADI (weekly) and 19 to 26 days for BRIXADI (monthly) as a result of the slow release of buprenorphine from the subcutaneous depot.

Metabolism:

Buprenorphine undergoes both N-dealkylation to norbuprenorphine and glucuronidation. The N-dealkylation pathway is mediated primarily by the CYP3A4. Norbuprenorphine, the major metabolite, can further undergo glucuronidation. Norbuprenorphine has been found to bind opioid receptors in vitro; however, it has not been studied clinically for opioid-like activity.

Norbuprenorphine steady-state plasma concentrations in humans after subcutaneous injection of BRIXADI (weekly or monthly) are low compared to buprenorphine (AUC norbuprenorphine/buprenorphine ratio of 0.35).

Excretion:

A mass balance study of buprenorphine showed complete recovery of radiolabel in urine (30%) and feces (69%) collected up to 11 days after dosing. Almost all of the dose was accounted for in terms of buprenorphine, norbuprenorphine, and two unidentified buprenorphine metabolites. In urine, most of the buprenorphine and norbuprenorphine was conjugated (buprenorphine, 1% free and 9.4% conjugated; norbuprenorphine, 2.7% free and 11% conjugated). In feces, almost all of the buprenorphine and norbuprenorphine were free (buprenorphine, 33% free and 5% conjugated; norbuprenorphine, 21% free and 2% conjugated).

Drug Interaction Studies:

CYP3A4 Inhibitors and Inducers

The effects of co-administered CYP3A4 inhibitors and inducers on buprenorphine exposure in subjects treated with BRIXADI have not been studied; however, such interactions have been established in studies using transmucosal buprenorphine. The effects of buprenorphine may be dependent on the route of administration.

Buprenorphine is metabolized to norbuprenorphine primarily by cytochrome CYP3A4; therefore, potential interactions may occur when BRIXADI is given concurrently with agents that affect CYP3A4 activity. The effects of co-administered CYP3A4 inducers or inhibitors have been established in studies using transmucosal buprenorphine. Patients who switch to BRIXADI treatment from a regimen for transmucosal buprenorphine used concomitantly with CYP3A4 inhibitors (e.g., ketoconazole, macrolide antibiotics (e.g., erythromycin) or HIV protease inhibitors, or CYP3A4 inducer (e.g., phenobarbital, carbamazepine, phenytoin, rifampicin) should be monitored to ensure that the plasma buprenorphine level provided by BRIXADI is adequate and not excessive [*see Drug Interactions (7)*].

Buprenorphine has been found to be a CYP2D6 and CYP3A4 inhibitor and its major metabolite, norbuprenorphine, has been found to be a moderate CYP2D6 inhibitor in in vitro studies employing human liver microsomes. However, plasma concentrations of buprenorphine and norbuprenorphine resulting from therapeutic BRIXADI doses are not expected to significantly affect the metabolism (systemic exposure) of other concomitantly administered medications [*see Drug Interactions (7)*].

Specific Populations

Based on population pharmacokinetic analyses, age, sex and race do not have a clinically meaningful effect on PK of BRIXADI.

Hepatic Impairment

The effect of hepatic impairment on the pharmacokinetics of BRIXADI has not been studied.

In a pharmacokinetic study, the disposition of buprenorphine was determined after administering a 2.0/0.5 mg Suboxone (buprenorphine/naloxone) sublingual tablet in subjects with varied degrees of hepatic impairment as indicated by Child-Pugh criteria. The disposition of

buprenorphine in patients with hepatic impairment was compared to disposition in subjects with normal hepatic function.

In subjects with mild hepatic impairment, the changes in mean C_{max} , AUC_{0-last} , and half-life values of buprenorphine were not clinically significant.

For subjects with moderate and severe hepatic impairment, mean C_{max} , AUC_{0-last} , and half-life values of buprenorphine were increased [see *Warnings and Precautions (5.14) and Use in Specific Populations (8.6)*].

Renal Impairment

The effect of renal impairment on the pharmacokinetics of BRIXADI has not been studied. Clinical studies of BRIXADI did not include subjects with severe renal impairment. Less than 1% is excreted as unchanged buprenorphine in urine following IV buprenorphine administration. No differences in buprenorphine pharmacokinetics were observed between 9 dialysis-dependent and 6 normal patients following IV administration of 0.3 mg buprenorphine [see *Use in Specific Populations (8.7)*].

Population PK analyses indicated no notable relationship between creatinine clearance and steady-state buprenorphine plasma concentrations.

HCV infection

In subjects with HCV infection but no sign of hepatic impairment, the changes in the mean C_{max} , AUC_{0-last} , and half-life values of buprenorphine were not clinically significant in comparison to healthy subjects without HCV infection.

13 NONCLINICAL TOXICOLOGY

13.1 Carcinogenesis, Mutagenesis, Impairment of Fertility

Carcinogenicity

Carcinogenicity studies of buprenorphine were conducted in Sprague-Dawley rats and CD-1 mice. Buprenorphine was administered in the diet to rats for 27 months at doses of 0.6, 5.5, and 56 mg/kg/day (0.3, 1.4 and 11.3 times the highest daily exposure from 32 mg BRIXADI (weekly) on an AUC basis and 0.2, 0.9 and 6.9 times the highest daily exposure from 128 mg BRIXADI (monthly) on an AUC basis). A statistically significant dose-related increase in Leydig cell tumors occurred. In an 86-week study in CD-1 mice, buprenorphine was not carcinogenic at dietary doses up to 100 mg/kg/day (7 and 4 times the highest daily exposure from 32 mg BRIXADI (weekly) or 128 mg BRIXADI (monthly), respectively, on an AUC basis).

NMP, an excipient in BRIXADI (monthly) produced an increase in hepatocellular adenomas and carcinomas in male and female mice at 47 and 60 times, respectively, the maximum daily dose (MDD) of NMP via 128 mg BRIXADI (monthly) on a mg/m² basis. The clinical significance of these findings is unclear. No tumors were noted in male or female mice at 7.4 and 9.5 times the MDD on a mg/m² basis. In 2-year inhalation and dietary studies in rats, NMP did not result in evidence of carcinogenicity.

Mutagenicity

Buprenorphine was studied in a series of tests utilizing gene, chromosome, and DNA interactions in both prokaryotic and eukaryotic systems. Results were negative in yeast (*S. cerevisiae*) for recombinant, gene convertant, or forward mutations; negative in *Bacillus subtilis* “rec” assay; negative for clastogenicity in CHO cells, Chinese hamster bone marrow and spermatogonia cells, and negative in the mouse lymphoma L5178Y assay.

Results were equivocal in the Ames test: negative in studies in two laboratories, but positive for frame shift mutation at a high dose (5 mg/plate) in a third study. Results were positive in the Green-Tweets (*E. coli*) survival test, positive in a DNA synthesis inhibition (DSI) test with testicular tissue from mice, for both in vivo and in vitro incorporation of [³ H]thymidine, and positive in unscheduled DNA synthesis test using testicular cells from mice.

Impairment of Fertility

Reproduction studies of buprenorphine in rats demonstrated no evidence of impaired fertility at daily oral doses up to 80 mg/kg/day (169 times the mean daily dose of 4.6 mg buprenorphine as delivered by 32 mg BRIXADI (weekly) or 128 mg BRIXADI (monthly) on a mg/m² basis) or up to 5 mg/kg/day IM (11 times the mean daily dose of 4.6 mg buprenorphine as delivered by 32 mg BRIXADI (weekly) or 128 mg BRIXADI (monthly) on a mg/m² basis) or 5 mg/kg/day SC (16 or 10 times the highest daily exposure from 32 mg BRIXADI (weekly) or 128 mg BRIXADI (monthly), respectively, on an AUC basis).

14 CLINICAL STUDIES

The key studies from the BRIXADI clinical development program that support its use in the treatment of moderate to severe opioid use disorder are a Phase 3, double-blind, active control (sublingual buprenorphine/naloxone), efficacy and safety study (NCT02651584), and an opioid blockade study (NCT02611752). Additionally, a Phase 3, open-label safety study (NCT0267211) provides data to support the safety of converting from daily transmucosal buprenorphine, buprenorphine/naloxone or generic equivalents.

14.1 Opioid Blockade Study, NCT02611752

The opioid blockade study assessed the blockade of subjective opioid effects, PK, and safety of BRIXADI weekly in 47 patients with moderate or severe opioid use disorder. Forty-six patients completed the study. Subjects were randomized to receive two injections of BRIXADI (weekly) once weekly for 2 weeks either at a 24 mg or 32 mg dose level.

After stabilization on immediate-release morphine, all patients completed a 3-day qualification/baseline hydromorphone (HM) challenge session, which included intramuscular administration of 3 doses of HM (0 mg [placebo], 6 mg and 18 mg) once daily for 3 consecutive days. Patients were not exposed to buprenorphine during the baseline/qualification phase.

Following the qualification phase, eligible patients were randomly assigned to receive 2 doses of either 24 mg (22 patients) or 32 mg (24 patients) BRIXADI (weekly) with each dose administered one week apart. Two HM challenge sessions (Days 1-3 and 4-6 for the first session and Days 8-10 and 11-13 for the second session, respectively) were conducted after each dose of BRIXADI (weekly).

The primary endpoint was the peak effect (E_{max}) on a 100-mm bipolar (i.e., 50=neutral response) “Drug Liking” Visual Analog Scale (VAS). The pre-defined upper bound of the 95% CI for complete blockade of drug liking was an 11 mm difference between VAS E_{max} scores obtained for HM doses compared with placebo.

During the qualification/baseline phase, mean E_{max} scores for placebo were neutral while intramuscular hydromorphone 6 and 18 mg produced dose-related increases in the scores. Beginning with the first injection of BRIXADI (weekly) 24 mg or 32 mg weekly, no active intramuscular hydromorphone dose resulted in a mean drug liking VAS E_{max} score of 11 mm or greater when compared to placebo, which demonstrated complete blockade that was sustained throughout the first and second dosing intervals (see Figure 15). Individual subject scores are shown in Figure 16.

Figure 15: Mean Difference in Placebo-Corrected Peak Drug Liking

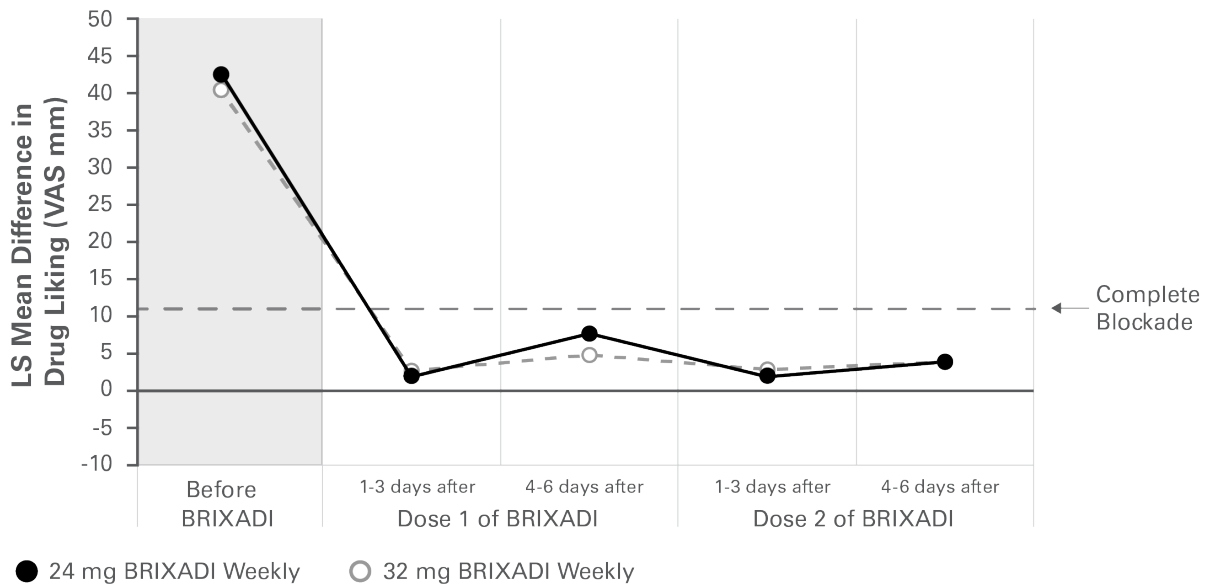
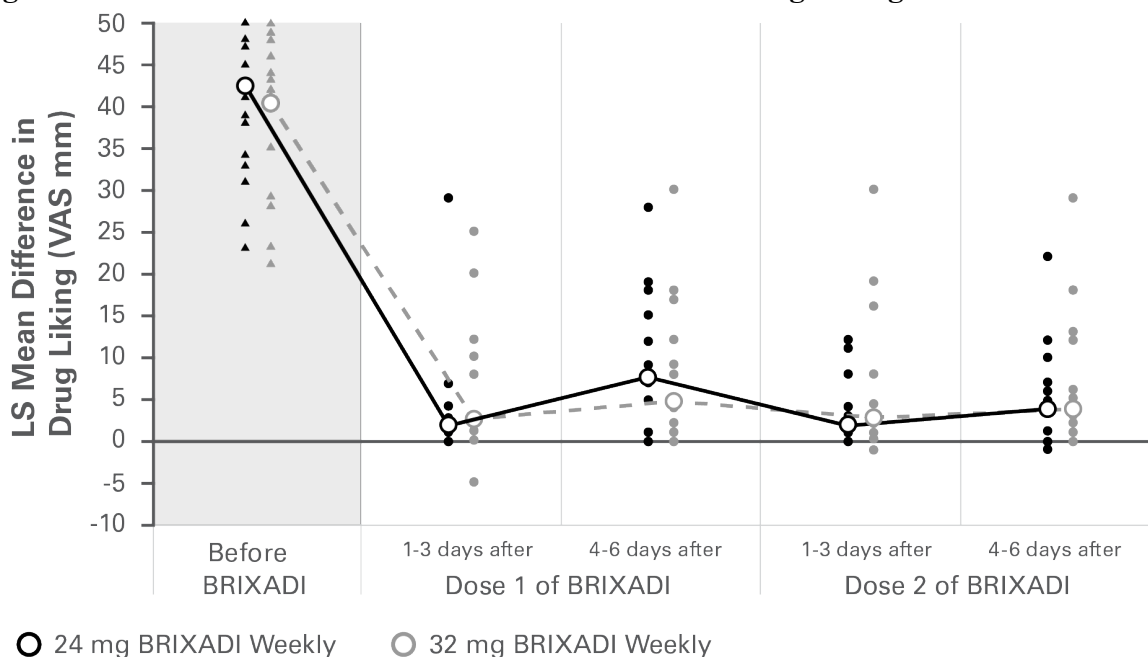

Figure 16: Mean Difference in Placebo-Corrected Peak Drug Liking with Individual Scores



14.2 Phase 3 Double-Blind Study, NCT02651584

The efficacy and safety of BRIXADI for the treatment of opioid use disorder was evaluated in a Phase 3, 24-Week, randomized, double-blind, double-dummy, active controlled, multicenter study in patients who met the DSM-5 criteria for moderate or severe opioid use disorder and who were actively seeking but not currently receiving buprenorphine treatment. Patients were randomized to receive either BRIXADI injections with placebo sublingual tablets or sublingual buprenorphine/naloxone (SL BPN/NX) tablets with placebo injections. All patients received individual drug counseling for the duration of the study.

On the first day of treatment patients received an open-label 4 mg test dose of sublingual buprenorphine. Patients who tolerated the test dose (two patients did not tolerate the test dose) were randomized and given a 16 mg injection of BRIXADI (weekly) or matched placebo. During the next 6 days patients were allowed up to two further 8 mg injections as needed. Patients received an injection of 16, 24, or 32 mg on Day 8 matched to the dose they received in the previous seven days. Patients received injections weekly (every 7 days +/- 2-day window) for twelve weeks total and then transitioned to an equivalent dose of BRIXADI (monthly) (every 28 days, +/- 7-day window) for the remaining twelve weeks. Dose adjustments were permitted for the duration of the study. Supplemental 8 mg BRIXADI (weekly) injections were allowed during the second phase of the study and were also used in the active-controlled group. Overall, supplemental 8 mg injections were given to 14 patients (6.6%) in the BRIXADI arm and 17 patients (7.9%) in the SL BPN/NX arm. Table 8 shows the doses of BRIXADI (weekly) administered following the initial titration period and at the final visit before transition to BRIXADI (monthly) was allowed. Table 9 shows the first and final BRIXADI (monthly) dose administered to each patient.

Table 8: Number of patients receiving each BRIXADI (weekly) dose at selected time points

| BRIXADI (weekly) Dose | Following Titration Period | End of Weekly Phase |
|------------------------------|-----------------------------------|----------------------------|
| 16 mg | 2 | 6 |
| 24 mg | 128 | 84 |
| 32 mg | 54 | 64 |

Table 9: Number of patients receiving each BRIXADI (monthly) dose at selected time points

| BRIXADI (monthly) Dose | First BRIXADI (monthly) dose | Final BRIXADI (monthly) dose |
|-------------------------------|-------------------------------------|-------------------------------------|
| 64 mg | 8 | 11 |
| 96 mg | 84 | 83 |
| 128 mg | 66 | 56 |
| 160 mg* | 0 | 8 |

*not an approved strength

For the first twelve weeks patients completed weekly visits. For the final twelve weeks patients were transitioned to monthly visits. Patients were also required to complete three additional randomly scheduled visits during the final twelve weeks. Efficacy was evaluated using urine drug screens combined with self-reported use of illicit opioid use. Missing urine drug screen samples and/or self-reports were counted as positive for illicit opioids.

A total of 428 patients were randomized equally (215 patients in the SL BPN/NX group and 213 in the BRIXADI group). Of the randomized patients, 69.0% (147/213) of the patients in BRIXADI treatment group and 72.6% (156/215) of the patients in the SL BPN/NX treatment group completed the 24-week period. Patient demographics and baseline characteristics are provided in Table 10.

Table 10: Patient Demographics and Baseline Characteristics

| | BRIXADI (N=213) | SL BPN/NX (N=215) |
|----------------------------|------------------------|--------------------------|
| Mean Age (Years) | 38.7 | 38.0 |
| Sex % | | |
| Male | 56.8 | 66.0 |
| Female | 43.2 | 34.0 |
| Race or Ethnicity % | | |
| White | 74.6 | 76.3 |
| Black or African American | 22.1 | 22.3 |

| | | |
|---|------|------|
| American Indian or Alaska Native | 0.9 | 0.5 |
| Asian | 0.5 | 0 |
| Native Hawaiian or Other Pacific Islander | 0.5 | 0 |
| Other | 1.4 | 0.9 |
| Primary Opioid of Use at Initiation % | | |
| Heroin | 71.4 | 70.2 |
| Prescription Pain Reliever | 28.6 | 29.8 |
| Injectable Route % | 53.5 | 51.2 |
| Substance Use by Urine Toxicology Prior to Randomization % | | |
| Amphetamines | 22.1 | 18.6 |
| Barbiturates | 1.4 | 0.5 |
| Benzodiazepine | 21.1 | 21.9 |
| Cocaine | 30.5 | 32.6 |
| Cannabinoids | 34.3 | 36.3 |
| Fentanyl | 29.1 | 22.8 |
| Phencyclidine | 1.9 | 0.5 |
| Medical History % | | |
| Anxiety | 14.1 | 18.6 |
| Back Pain | 15.5 | 18.6 |
| Depression | 11.7 | 13.0 |

Table 11 below illustrates the proportion of patients who were considered to be responders. A patient was a responder if they met all of the following criteria:

- Negative opioid assessment (urinalysis and self-report) during week 12 (evaluated during week 13 visit).
- No more than one positive opioid assessment in the three illicit opioid use assessments performed during week 9 to 11 (evaluated during visits at weeks 10 to 12).
- Negative opioid assessment during the final month of the study.
- No more than one positive opioid assessment at the three scheduled monthly visits and three random site visits.

This responder definition was designed to identify patients who were successfully treated with both BRIXADI (weekly) (administered in the first 12 weeks of treatment) and BRIXADI (monthly) (administered in the second 12 weeks of treatment). Therefore, patients were required to have negative opioid assessments at the end of each treatment phase. Each phase also included an allowable grace period (an initial period of time when positive opioid assessments were not taken into account) and the definition also allowed for sporadic positive assessments. Based on the results of this trial, the efficacy of BRIXADI was demonstrated. Table 11 shows the response

rate for each treatment arm along with the associated 95% confidence interval for their difference.

Table 11: Number (Percentage) of Patients who met the Responder Definition

| BRIXADI Injection with placebo sublingual tablets (N=213) | SL BPN/NX Tablets with Placebo Injections (N=215) | Treatment Difference (95% CI) |
|--|--|--------------------------------------|
| 36 (16.9%) | 30 (14.0%) | 2.9% (-3.9%, 9.8%)* |

* The lower bound of the confidence interval was within the agreed upon noninferiority threshold of -10%.

The cumulative distribution function (CDF) of the percentage of negative opioid assessments (urine samples negative for illicit opioid use combined with self-reports negative for illicit opioid use) from Week 4 through Week 24 are shown in Figure 17 and Table 12. The figure and table are cumulative, so that a patient whose percentage of opioid-free assessments is, for example 50%, is also included at every level of negative opioid assessments below 50%. Missing values and values after premature discontinuation were considered positive. Based on the CDF of the percentage of negative opioid assessments, superiority was demonstrated with BRIXADI with statistical significance compared with SL BPN/NX. However, on the right-hand side of the curves where patients were reporting mostly negative opioid assessments (80% or greater) there was little to no difference between BRIXADI and SL BPN/NX.

Figure 17: Patients Achieving Varying Percentages of Negative Opioid Assessments (urine and self-report) in weeks 4 through 24

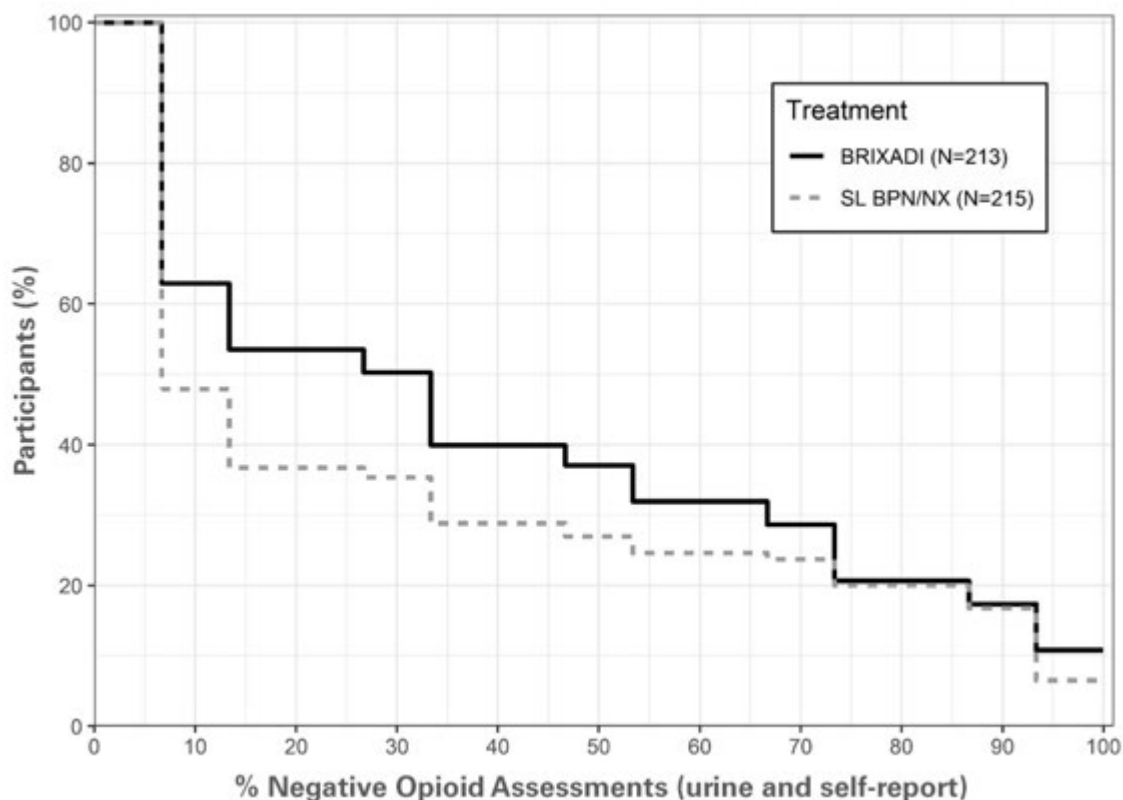

Table 12: Patients Achieving Varying Percentage of Opioid-Negative Assessments (urine and self report) (Weeks 4-24)

| Percentage of Opioid-Negative Assessments (Urine and Self Report) | Number (%) of Patients | |
|---|------------------------|--------------------|
| | BRIXADI N=213 | SL BPN/NX N=215 |
| ≥ 0% | 213 (100.0) | 215 (100.0) |
| ≥ 10% | 121 (56.8) | 87 (40.5) |
| ≥ 20% | 114 (53.5) | 79 (36.7) |
| ≥ 30% | 95 (44.6) | 67 (31.2) |
| ≥ 40% | 85 (39.9) | 62 (28.8) |
| ≥ 50% | 74 (34.7) | 56 (26.0) |
| ≥ 60% | 68 (31.9) | 53 (24.7) |
| ≥ 70% | 51 (23.9) | 49 (22.8) |
| ≥ 80% | 44 (20.7) | 43 (20.0) |
| ≥ 90% | 28 (13.1) | 27 (12.6) |
| ≥ 100% | 23 (10.8) | 14 (6.5) |

16 HOW SUPPLIED/STORAGE AND HANDLING

Weekly and monthly BRIXADI is available as a sterile, yellowish to yellow clear liquid solution in a single dose, prefilled safety syringe.

The BRIXADI needle cap is synthetically derived from natural rubber latex, which may cause allergic reactions in latex sensitive individuals.

Store BRIXADI at room temperature at 20°C to 25°C (68°F to 77° F); with excursions permitted at 15°C to 30° C (59°F to 86°F) [see USP Controlled Room Temperature].

BRIXADI is a Schedule III drug product. Handle with adequate security and accountability. After administration, syringes should be properly disposed, per facility procedure for a Schedule III drug product, and per applicable federal, state, and local regulations.

| BRIXADI Weekly 50 mg/mL buprenorphine | | |
|--|---------------|------------------------------|
| Dosage | Volume | NDC |
| 8 mg | 0.16 mL | 58284-208-01 58284-208-91 |
| 16 mg | 0.32 mL | 58284-216-01 58284-216-91 |
| 24 mg | 0.48 mL | 58284-224-01 58284-224-91 |
| 32 mg | 0.64 mL | 58284-232-01 58284-232-91 |

| BRIXADI Monthly 356 mg/mL buprenorphine | | |
|--|---------------|------------------------------|
| Dosage | Volume | NDC |
| 64 mg | 0.18 mL | 58284-264-01 58284-264-91 |
| 96 mg | 0.27 mL | 58284-296-01 58284-296-91 |
| 128 mg | 0.36 mL | 58284-228-01 58284-228-91 |

17 PATIENT COUNSELING INFORMATION

Advise the patient to read the FDA-approved patient labeling (Medication Guide).

Instruct patients to read the Medication Guide each time BRIXADI is administered because new information may be available.

Safe Use

Before initiating treatment with BRIXADI, explain the points listed below to patients and caregivers.

BRIXADI Risk Evaluation and Mitigation Strategy (REMS)

Advise patients that because of the risk of serious harm or death due to intravenous self-administration, BRIXADI is available only through a restricted distribution program called the BRIXADI REMS. Healthcare settings and pharmacies are certified and only dispense BRIXADI directly to a healthcare provider for administration by a healthcare provider [*see Warnings and Precautions (5.2)*].

Life Threatening Respiratory Depression

Educate patients and caregivers on how to recognize respiratory depression and emphasize the importance of calling 911 or getting emergency medical help right away in the event of a known or suspected overdose [*see Warnings and Precautions 5.4*].

Patient Access to Naloxone for the Emergency Treatment of Opioid Overdose

Because patients being treated for opioid use disorder are at risk for relapse, discuss the importance of having access to naloxone with the patient and caregiver. Also discuss the importance of having access to naloxone if there are household members (including children) or other close contacts at risk for accidental ingestion or opioid overdose.

Inform patients and caregivers of the options for obtaining naloxone as permitted by individual state naloxone dispensing and prescribing requirements or guidelines (e.g., by prescription, directly from a pharmacist, or as part of a community-based program).

Educate patients and caregivers on how to recognize the signs and symptoms of an opioid overdose.

Explain to patients and caregivers that naloxone's effects are temporary, and that they must call 911 or get emergency medical help right away in all cases of known or suspected opioid overdose, even if naloxone is administered.

Repeat administration may be necessary, particularly for overdose involving buprenorphine, because naloxone is often not effective at the doses available for patient access [*Dosage and Administration (2.3), Warnings and Precautions (5.4), Overdosage (10)*].

If naloxone is prescribed, also advise patients and caregivers:

- How to treat with naloxone in the event of an opioid overdose
- To tell family and friends about their naloxone and to keep it in a place where family and friends can easily access it in an emergency
- To read the Patient Information (or other educational material) that will come with their naloxone. Emphasize the importance of doing this before an opioid emergency happens, so the patient and caregiver will know what to do.

Interaction with Benzodiazepines and other CNS Depressants

Inform patients and caregivers that potentially fatal additive effects may occur if BRIXADI is used with benzodiazepines or other CNS depressants, including alcohol, and not to use these concomitantly unless supervised by a healthcare provider [see *Warnings and Precautions (5.5) and Drug Interactions (7)*].

Serotonin Syndrome

Inform patients that BRIXADI could cause a rare but potentially life-threatening condition resulting from concomitant administration of serotonergic drugs. Warn patients of the symptoms of serotonin syndrome and to seek medical attention right away if symptoms develop. Instruct patients to inform their physicians if they are taking, or plan to take serotonergic medications [see *Drug Interactions (7)*].

Adrenal Insufficiency

Inform patients that BRIXADI could cause adrenal insufficiency, a potentially life-threatening condition. Adrenal insufficiency may present with non-specific symptoms and signs such as nausea, vomiting, anorexia, fatigue, weakness, dizziness, and low blood pressure. Advise patients to seek medical attention if they experience a constellation of these symptoms [see *Warnings and Precautions (5.7)*].

Anaphylaxis

Inform patients that anaphylaxis has been reported with buprenorphine. Advise patients how to recognize such a reaction and when to seek medical attention [see *Warnings and Precautions (5.10)*].

Latex Allergy

The BRIXADI needle cap is synthetically derived from natural rubber latex which may cause allergic reactions in latex-sensitive individuals [see *Warnings and Precautions (5.10)*].

Dependence and Withdrawal

Inform patients that BRIXADI can cause drug dependence and that withdrawal signs and symptoms may occur when the medication is discontinued [see *Warnings and Precautions (5.11)*].

Driving or Operating Heavy Machinery

Caution patients that BRIXADI may impair the mental or physical abilities required for the performance of potentially dangerous tasks such as driving or operating hazardous machinery.

Instruct patients not to drive or operate hazardous machinery until they are reasonably certain that BRIXADI therapy does not adversely affect their ability to engage in such activities [see *Warnings and Precautions (5.16)*].

Orthostatic Hypotension

Inform patients that, like other opioids, BRIXADI may produce orthostatic hypotension in ambulatory individuals [see *Warnings and Precautions (5.17)*].

Long Duration of Action

Inform patients that they may have detectable levels of buprenorphine for a prolonged period of time after treatment with BRIXADI. Considerations of drug-drug interactions, buprenorphine

effects, and analgesia may continue to be relevant for several months after the last injection [*see Clinical Pharmacology (12.3)*].

Drug Interactions

Instruct patients to inform their healthcare providers of any other prescription medications, over-the-counter medications, or herbal preparations that are prescribed or currently being used [*see Drug Interactions (7)*].

Pregnancy

Neonatal Opioid Withdrawal Syndrome

Advise women that if they are pregnant while being treated with BRIXADI, the baby may have signs of withdrawal at birth and that withdrawal is treatable [*see Warnings and Precautions (5.6), Use in Specific Populations (8.1)*].

Embryofetal Toxicity

Advise women of childbearing potential who become pregnant or are planning to become pregnant to consult their healthcare provider regarding the possible effects of using BRIXADI during pregnancy [*see Use in Specific Populations (8.1)*].

Lactation

Warn patients that buprenorphine passes into breast milk. Advise the nursing mother taking buprenorphine to monitor the infant for increased drowsiness and breathing difficulties [*see Use in Specific Populations (8.2)*].

Infertility

Inform patients that chronic use of opioids may cause reduced fertility. It is not known whether these effects on fertility are reversible [*see Infertility (8.3)*].

Emergency Analgesia

Advise patients to instruct their family members to, in the event of emergency, inform the treating physician or emergency room staff that the patient is physically dependent on an opioid and that the patient is being treated with BRIXADI [*see Warnings and Precautions (5.12)*].

Clinical Monitoring

Tell your patients to seek emergency attention if they have signs or symptoms of respiratory or CNS depression or overdose [*see Warnings and Precautions (5.4, 5.5)*].

Tell your patients not to tamper with or try to remove their depot [*see Dosage and Administration (2.6)*].

BRIXADI™ is a trademark of Braeburn Inc.

Distributed by:
Braeburn Inc.
Plymouth Meeting, PA 19462

Manufactured by:
Pharmaceuticals International, Inc. (Pii)
Cockeysville, MD 21030

BRIX-001-01 xx/2022